

Winter Promo 09/10

Precision Tools & Instruments

Prices effective November 1, 2009 through February 26, 2010

Deep Discounts!
Savings of up to **20%!!**



Calipers



Coolant Proof Calipers

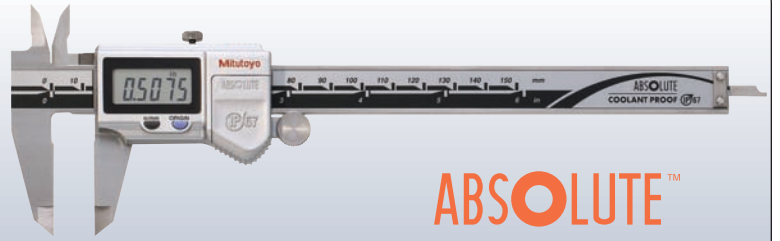

ABSOLUTE™
Absolute System Patented by MITUTOYO

Order No.	Measuring Range	List Price	Sale Price
Non-Output Style			
500-752-10	0-6"/0-150mm	\$181.00	\$172.00
500-753-10	0-8"/0-200mm	\$227.00	\$216.00
500-754-10	0-12"/0-300mm	\$330.00	\$314.00
SPC Output Style			
500-762-10	0-6"/0-150mm	\$215.00	\$205.00
500-769-10*	0-6"/0-150mm	\$242.00	\$230.00
500-763-10	0-8"/0-200mm	\$270.00	\$257.00
500-764-10	0-12"/0-300mm	\$407.00	\$387.00

FEATURES

- It's sealed housing is IP-67 rated, meaning it's immune to the coolants, dirt, grit and chips found in many manufacturing environments.
- .0005"/0.01mm resolution with $\pm .001$ " accuracy for 6" models and 8" models.
- Certificate of inspection provided (4"/6"/8" models).

*Round Depth Rod



Order No.	Description	List Price	Sale Price
05CZA624	40" IP Caliper Cable	\$81.30	\$78.00
05CZA625	80" IP Caliper Cable	\$82.50	\$79.00



Digimatic Calipers with Absolute Encoder

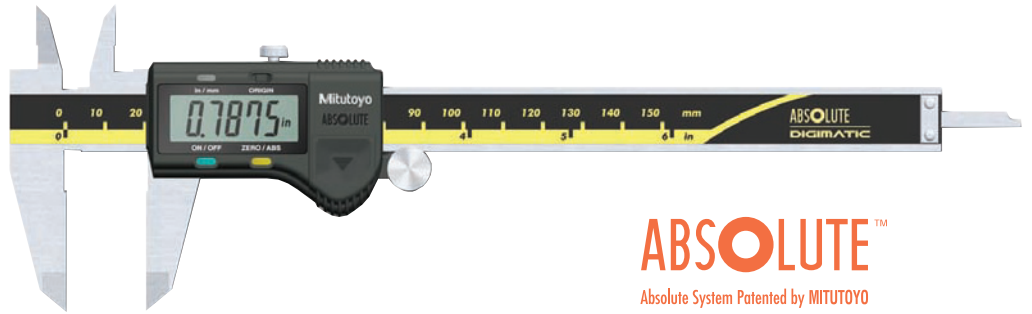

ABSOLUTE™
Absolute System Patented by MITUTOYO

Order No.	Measuring Range	Remarks	List Price	Sale Price
Non-Output Style				
500-195-20	0-4"/0-100mm	.075" Round depth bar	\$128.00	\$122.00
500-196-20	0-6"/0-150mm		\$141.00	\$134.00
500-197-20	0-8"/0-200mm		\$199.00	\$190.00
500-164-20	0-8"/0-200mm	Carbide OD/ID Jaws	\$346.00	\$329.00
500-193	0-12"/0-300mm		\$390.00	\$371.00
With SPC Output Style				
500-170-20	0-4"/0-100mm	.075" Round depth bar	\$152.00	\$145.00
500-171-20	0-6"/0-150mm		\$163.00	\$155.00
500-174-20	0-6"/0-150mm	with OD carbide jaw	\$311.00	\$296.00
500-175-20	0-6"/0-150mm	with OD, ID carbide jaw	\$332.00	\$316.00
500-172-20	0-8"/0-200mm		\$214.00	\$204.00
500-176-20	0-8"/0-200mm	with OD carbide jaw	\$346.00	\$329.00
500-177-20	0-8"/0-200mm	with OD, ID carbide jaw	\$365.00	\$347.00
500-173	0-12"/0-300mm		\$455.00	\$433.00
500-505-10	0-18"/0-450mm	Without Thumb Roller	\$710.00	\$675.00
500-506-10	0-24"/0-600mm	Without Thumb Roller	\$780.00	\$741.00
500-507-10	0-40"/0-1000mm	Without Thumb Roller	\$1,500.00	\$1,425.00



Order No.	Description	List Price	Sale Price
959149	40" Caliper Cable	\$43.65	\$42.00
959150	80" Caliper Cable	\$48.90	\$47.00

Calipers



Solar Calipers

Order No.	Measuring Range	Remarks	List Price	Sale Price
500-473*	0-4"/0-100mm	w/no output	\$156.00	\$133.00
500-474	0-6"/0-150mm	w/no output	\$169.00	\$144.00
500-475	0-8"/0-200mm	w/no output	\$220.00	\$187.00
500-463*	0-4"/0-100mm	w/output	\$225.00	\$192.00
500-464	0-6"/0-150mm	w/output	\$264.00	\$225.00
500-465	0-8"/0-200mm	w/output	\$308.00	\$262.00

* With round depth rod



UP TO 15% OFF!

FEATURES

- Absolute Encoder Technology
- No battery needed
- Works in low lighting conditions above 60 luxes
- 0.0005"/0.01mm resolution
- Supplied in fitted plastic case



Order No.	Description	List Price	Sale Price
959149	40" Caliper Cable	\$43.65	\$42.00
959150	80" Caliper Cable	\$48.90	\$47.00

Super Solar Caliper (World's only IP67 Solar Caliper)

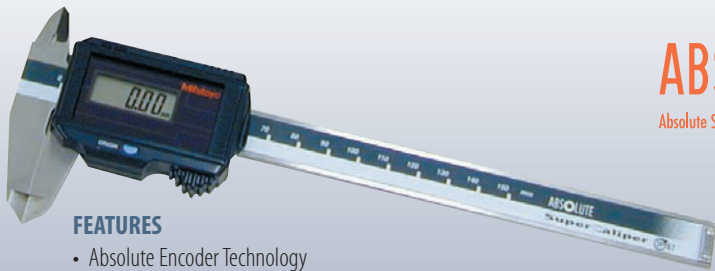

FEATURES

- Absolute Encoder Technology
- IP-67 Coolant Proof Rating
- No battery needed
- Works in low lighting conditions above 60 luxes
- Super capacitor power back-up
- 0.0005"/0.01mm resolution
- Certificate of Inspection provided
- RoHS Compliant

UP TO 15% OFF!

ABSOLUTE™
Absolute System Patented by MITUTOYO

RoHS
COMPLIANT



Order No.	Measuring Range	Remarks	List Price	Sale Price
500-784	0-6"/0-150mm	w/no output	\$204.00	\$174.00
500-785	0-8"/0-200mm	w/no output	\$266.00	\$227.00
500-786	0-6"/0-150mm	w/output	\$231.00	\$197.00
500-787	0-8"/0-200mm	w/output	\$286.00	\$244.00

Order No.	Description	List Price	Sale Price
05CZA624	40" IP Caliper Cable	\$81.30	\$78.00
05CZA625	80" IP Caliper Cable	\$82.50	\$79.00



Digimatic Plastic Calipers

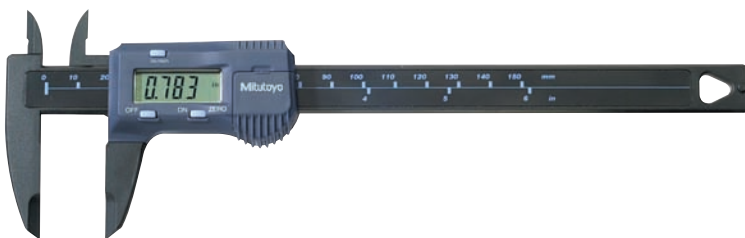

Plastic-Cal—our first multi-purpose, non-industrial-use digital caliper!

Ideal for use in the lab, the woodshop, the classroom, the nursery, the doctor's office—any application involving delicate or unusual workpieces. Plastic construction makes for durable and light-weight use, and plastic jaws won't mar easily-damaged surfaces.

Reads in inch or millimeters.
Alarm: Battery voltage low
Over speed

Response speed: 63"/s (1,600mm/s)
Without SPC output and Depth Bar.

Inch/Metric

Order No.	700-126
Range	0-6" (0-150mm)
Resolution	.001" (0.1mm)
Accuracy	±.008" (±0.2mm)
Remarks	Black
List Price	\$45.35
Sale Price	\$39.00

Calipers



MyCAL Lite

FEATURES

- Economically priced
- Large LCD digits
- .001"/0.1mm resolution
- Accuracy: ±.005"

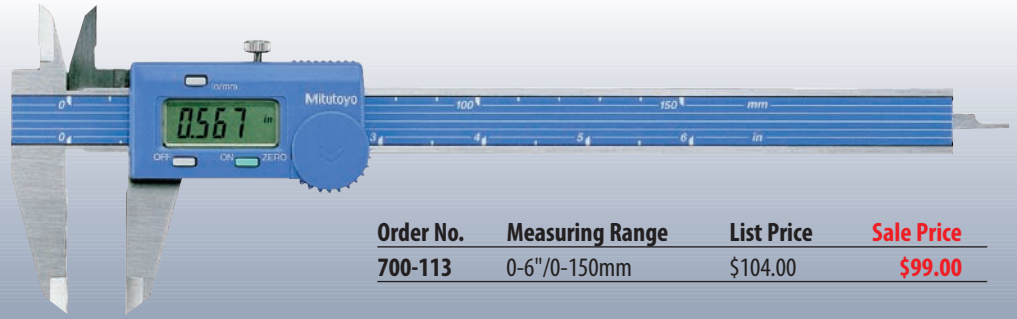

Order No.	Measuring Range	List Price	Sale Price
700-113	0-6"/0-150mm	\$104.00	\$99.00

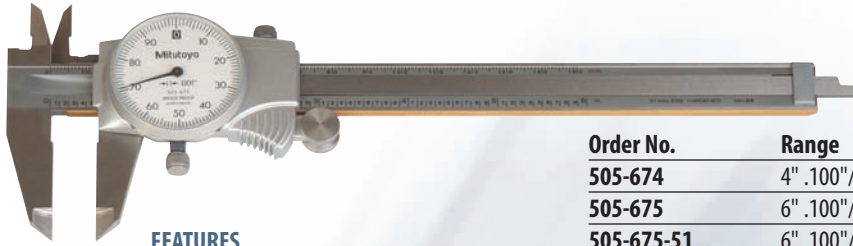

FEATURES

- Stainless Steel
- Mitutoyo has improved the durability of its calipers by using a TiN coating on the sliding surfaces of the 4", 6" and 8" main beam.
- .001" graduations

Dial Calipers

Order No.	Range	Remarks	List Price	Sale Price
505-674	4" .100"/rev.		\$94.35	\$90.00
505-675	6" .100"/rev.		\$112.00	\$107.00
505-675-51	6" .100"/rev.	Blue Face	\$112.00	\$107.00
505-675-52	6" .100"/rev.	Violet Face	\$112.00	\$107.00
505-675-53	6" .100"/rev.	Green Face	\$112.00	\$107.00
505-675-54	6" .100"/rev.	Red Face	\$112.00	\$107.00
505-675-55	6" .100"/rev.	Orange Face	\$112.00	\$107.00
505-675-56	6" .100"/rev.	Black Face	\$112.00	\$107.00
505-675-66	6" .100"/rev.	Black Face with Ratchet	\$119.00	\$114.00
505-676	8" .100"/rev.		\$163.00	\$155.00
505-677	12" .100"/rev.		\$243.00	\$231.00

Carbon Fiber Digimatic Calipers

FEATURES

- Lightweight Digimatic Calipers that employ CFRP (Carbon Fiber Reinforced Plastics) in the beam and jaws.
- Highly durable and easy to handle.
- The range of applications can be expanded by using the optional attachments.
- Direct readout of ID measurements from the LCD. (Offset value can be set easily by pressing the Offset key.)
- Preset function for setting a desired starting point.
- With SPC data output.
- Special models available with ceramic jaws which are suitable for measuring abrasive and magnetic products.
- Supplied in fitted wooden case.
- .0005"/0.01mm Resolution



New!

Order No.	Range	List Price	Sale Price
552-312-10	18"/450mm	\$821.00	\$780.00
552-313-10	24"/600mm	\$913.00	\$868.00
552-314-10	40"/1000mm	\$1,640.00	\$1,558.00
552-315-10	60"/1500mm	\$1,960.00	\$1,862.00
552-316-10	80"/2000mm	\$3,070.00	\$2,917.00

Order No.	Description	List Price	Sale Price
05CZA624	40" IP Caliper Cable	\$81.30	\$78.00
05CZA625	80" IP Caliper Cable	\$82.50	\$79.00



Depth Base Attachments

FEATURES

- For 4", 6", 8" and 12" / 100mm, 150mm, 200mm, 300mm calipers which have a depth measuring bar.
- Finely ground base surface and secure locking clamp.

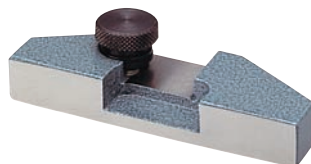

Order No.	Description	List Price	Sale Price
050083	3" Depth Base Attachment for 4", 6", 8" Calipers	\$38.05	\$37.00
050084	4" Depth Base Attachment for 4", 6", 8" Calipers	\$46.65	\$45.00
050085	5" Depth Base Attachment for 12" Calipers	\$55.25	\$53.00

Micrometers



QuantuMike Micrometers



UP TO 10% OFF!

FEATURES

- Faster measurement with 2mm travel per revolution instead of the standard 0.5mm
- A patented ratchet thimble mechanism helps ensure repeatability
- A Function lock helps prevent error
- IP-65 protection level
- Certificate of inspection is provided

Order No.	Range	Resolution	List Price	Sale Price
293-180*	0-1"/0-25mm	.00005"/0.001mm	\$228.00	\$206.00
293-181*	1-2"/25-50mm	.00005"/0.001mm	\$260.00	\$234.00
293-182*	2-3"/50-75mm	.00005"/0.001mm	\$310.00	\$279.00
293-183*	3-4"/75-100mm	.00005"/0.001mm	\$334.00	\$301.00
293-185	0-1"/0-25mm	.00005"/0.001mm	\$196.00	\$177.00
293-186	1-2"/25-50mm	.00005"/0.001mm	\$224.00	\$202.00
293-187	2-3"/50-75mm	.00005"/0.001mm	\$268.00	\$242.00
293-188	3-4"/75-100mm	.00005"/0.001mm	\$322.00	\$290.00
293-140*	0-25mm	0.001mm	\$228.00	\$206.00
293-141*	25-50mm	0.001mm	\$260.00	\$234.00

*with SPC Output



Order No.	Description	List Price	Sale Price
05CZA662	40" IP65 Mic Cable	\$72.55	\$69.00
05CZA663	80" IP65 Mic Cable	\$80.00	\$76.00

IP65 Coolant Proof Micrometers

293-340
Ratchet Stop



293-348
Friction
Thimble



293-344
New Ratchet Friction
Thimble (internal
"clicking" ratchet)



FEATURES

- 0-1"/0-25mm, 1-2"/25-50mm micrometers supplied with Certificate of Inspection
- Extra large LCD readout.
- Two measuring modes—ABS (absolute) and INC (incremental)—for efficient measurement.
- TÜV certified
- Functions available: Origin setting, Inch/mm selection, Zero-setting, Data Hold (with SPC Models), Error alarm, Auto-sleep, Data output (where noted).
- Carbide-tipped measuring faces.

Order No.	Range	Resolution	Remarks	List Price	Sale Price
With SPC Output					
293-330	0-1"/0-25.4mm	.00005"/0.001mm	Ratchet Stop	\$207.00	\$197.00
293-334	0-1"/0-25.4mm	.00005"/0.001mm	Ratchet Friction Thimble	\$221.00	\$210.00
293-335	0-1"/0-25.4mm	.00005"/0.001mm	Friction Thimble	\$207.00	\$197.00
293-331	1-2"/25.4-50.8mm	.00005"/0.001mm	Ratchet Stop with Standard	\$244.00	\$232.00
293-336	1-2"/25.4-50.8mm	.00005"/0.001mm	Friction Thimble with Standard	\$244.00	\$232.00
293-332	2-3"/50.8-76.2mm	.00005"/0.001mm	Ratchet Stop with Standard	\$301.00	\$286.00
293-333	3-4"/76.2-101.6mm	.00005"/0.001mm	Ratchet Stop with Standard	\$324.00	\$308.00
Non-SPC Output					
293-340	0-1"/0-25.4mm	.00005"/0.001mm	Ratchet Stop	\$153.00	\$146.00
293-344	0-1"/0-25.4mm	.00005"/0.001mm	Ratchet Friction Thimble	\$153.00	\$146.00
293-348	0-1"/0-25.4mm	.00005"/0.001mm	Friction Thimble	\$153.00	\$146.00
293-349	0-1"/0-25.4mm	.0001"/0.001mm	Ratchet Friction Thimble	\$153.00	\$146.00
293-341	1-2"/25.4-50.8mm	.00005"/0.001mm	Ratchet Stop with Standard	\$210.00	\$200.00
293-345	1-2"/25.4-50.8mm	.00005"/0.001mm	Ratchet Friction Thimble with Standard	\$210.00	\$200.00
293-342	2-3"/50.8-76.2mm	.00005"/0.001mm	Ratchet Stop with Standard	\$261.00	\$248.00
293-346	2-3"/50.8-76.2mm	.00005"/0.001mm	Ratchet Friction Thimble with Standard	\$275.00	\$262.00
293-343	3-4"/76.2-101.6mm	.00005"/0.001mm	Ratchet Stop with Standard	\$313.00	\$298.00
293-347	3-4"/76.2-101.6mm	.00005"/0.001mm	Ratchet Friction Thimble with Standard	\$296.00	\$282.00
293-350-10	4-5"/101.6-127mm	.0001"/0.001mm	Ratchet Stop with Standard	\$401.00	\$381.00

Micrometers



Digimatic Micrometer

MDC-Lite



FEATURES

- Provided with a zero-set key for easy origin setting.
- A ratchet stop or friction thimble for a constant measuring force.
- Measurement readout with large characters on the LCD screen.
- No spindle clamp. No data output
- Supplied in fitted plastic case

Order No.	Range	LCD Resolution	Accuracy	Remarks	List Price	Sale Price
293-831	0-1"	.00005"	±.0001"	Ratchet Stop	\$116.00	\$111.00
	0-25.4mm	0.001mm				
293-832	0-1"	.00005"	±.0001"	Friction Thimble	\$119.00	\$114.00
	0-25.4mm	0.001mm				

IP65 Uni-Mike



317-351

FEATURES

- Measures tube thickness, shoulder-edge distance, rivet head height, etc. with interchangeable anvils (flat anvil, rod anvil, V-anvil).
- Supplied with flat anvil and rod anvil.

Order No.	Range	LCD Resolution	Accuracy	Remarks	List Price	Sale Price
317-351	0-1"	.00005"	±.0002"	Interchangeable Anvils IP-65 with SPC output	\$458.00	\$436.00
	0-25mm	0.001mm				
317-352	1-2"	.00005"	±.0002"	Interchangeable Anvils IP-65 with SPC output	\$467.00	\$444.00
	25-50mm	0.001mm				

Order No.	Description	List Price	Sale Price
05CZA662	40" IP65 Mic Cable	\$72.55	\$69.00
05CZA663	80" IP65 Mic Cable	\$80.00	\$76.00



Uni-Mike



117-107

FEATURES

- Measures tube thickness, shoulder-edge distance, rivet head height, etc. with interchangeable anvils (flat anvil, rod anvil, V-anvil).
- Supplied with flat anvil and rod anvil.

Order No.	Measuring Range	Graduations	Remarks	List Price	Sale Price
117-107	0-1"	.0001"		\$180.00	\$171.00
117-108	1-2"	.0001"	w/1" standard	\$211.00	\$201.00

Micrometer Stand

Micrometer sold separately

The micrometer stand is designed to provide the convenience of a benchtop tool with hand micrometers or other gages.

Order No.	Description	Mic Range	List Price	Sale Price
156-101	Micrometer Stand	0-4"	\$95.30	\$91.00
156-105	Micrometer Stand	0-2"	\$67.85	\$62.00

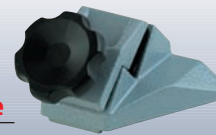

156-105



156-101

Digit Outside Micrometers

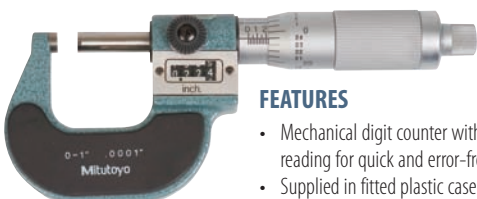

FEATURES

- Mechanical digit counter with .001" reading for quick and error-free reading.
- Supplied in fitted plastic case.

Order No.	Range	Graduation	Remarks	List Price	Sale Price
193-211	0-1"	.0001"	Friction Thimble	\$161.00	\$153.00
193-212	1-2"	.0001"	Friction Thimble w/standard	\$190.00	\$181.00
193-213	2-3"	.0001"	Ratchet Stop w/standard	\$212.00	\$202.00
193-214	3-4"	.0001"	Ratchet Stop w/standard	\$235.00	\$224.00

Tool Kits



Basic Tool Kit with Micrometer, Caliper and Steel Rule

Consisting of:

182-112	6" (16R) Black Chrome Steel Rule
103-105	0-1" .001" Micrometer with Ratchet Stop
505-717	0-6" .200" per Rev. Dial Caliper
050516	Mahogany Case

\$190.00

Our Regular Price: \$199.00
Order Number: **950-920**



Digimatic Micrometer & Caliper Tool Kit



The Digimatic Tool Kits include Mitutoyo's highly popular 0-1" Digimatic Micrometer (choose ratchet or friction type) and 0-6" Digimatic Caliper with Absolute Encoder. The case is made of handsome, solid mahogany and has space for gage batteries. The micrometer spanner is a supplied accessory.

Order No. 950-939-9 (Digimatic Tool Kit)	List Price	Sale Price	Order No. 950-940-9 (Digimatic Tool Kit)	List Price	Sale Price
Set Includes:	\$354.00	\$337.00	Set Includes:	\$354.00	\$337.00
293-340 Digimatic Micrometer (Ratchet Stop Type) (Range: 0-1"/0-25.4mm, LCD Resolution: .00005"/0.001mm)			293-348 Digimatic Micrometer (Friction Thimble Type) (Range: 0-1"/0-25.4mm, LCD Resolution: .00005"/0.001mm)		
500-196-20 Digimatic Caliper with Absolute Encoder (Range: 0-6"/0-150mm, LCD Resolution: .0005"/0.01mm)			500-196-20 Digimatic Caliper with Absolute Encoder (Range: 0-6"/0-150mm, LCD Resolution: .0005"/0.01mm)		

Inch Tool Kit

Consisting of:

103-135	Outside Micrometer (Friction Thimble Type) (Range: 0-1", Graduation: .0001")
505-675	Dial Caliper (Range: 0-6", Dial Graduation: .001")
182-204	6" Full-Flexible Rule (3R)
050516	Mahogany Case

\$264.00

Our Regular Price: \$277.00
Order Number: **950-903**



Tool Kit Lite w/(Ratchet Thimble)

Consisting of:

182-112	6" (16R) Black Chrome Steel Rule
700-113	0-6"/0-150mm MyCal Lite (Resolution: .001"/0.1mm)
293-831	0-1"/0-25.4mm MDC Lite (Ratchet Thimble) (Resolution: .00005"/0.001mm)
64PPP932	Mahogany Case

\$250.00

Our Regular Price: \$263.00
Order Number: **950-921**



Tool Kit Lite w/(Friction Thimble)

Consisting of:

182-112	6" (16R) Black Chrome Steel Rule
700-113	0-6"/0-150mm MyCal Lite (Resolution: .001"/0.1mm)
293-832	0-1"/0-25.4mm MDC Lite (Friction Thimble) (Resolution: .00005"/0.001mm)
64PPP932	Mahogany Case

\$250.00

Our Regular Price: \$263.00
Order Number: **950-922**



Holtests



New Holtests with a TiN Anvil Coating

FEATURES

- A constant force ratchet design for more repetitive measurements
- TiN coated anvils for longer wear life
- Certificate of Inspection provided
- New "cut pin method" keeps pins from sliding out of holder



Order No.	Measuring Range	Graduation	List Price	Sale Price
368-261	.275"-.350"	.0001"	\$518.00	\$493.00
368-262	.350"-.425"	.0001"	\$518.00	\$493.00
368-263	.425"-.500"	.0001"	\$518.00	\$493.00
368-264	.500"-.650"	.0002"	\$538.00	\$512.00
368-265	.650"-.800"	.0002"	\$538.00	\$512.00
368-266	.800"-1.0"	.0002"	\$559.00	\$532.00
368-267	1.0"-1.2"	.0002"	\$559.00	\$532.00
368-268	1.2"-1.6"	.0002"	\$698.00	\$664.00

Order No.	Measuring Range	Graduation	List Price	Sale Price
368-269	1.6"-2.0"	.0002"	\$737.00	\$701.00
368-270	2.0"-2.5"	.0002"	\$741.00	\$704.00
368-271	2.5"-3.0"	.0002"	\$804.00	\$764.00
368-272	3.0"-3.5"	.0002"	\$826.00	\$785.00
368-273	3.5"-4.0"	.0002"	\$864.00	\$821.00

IP65 Digimatic Holtest

The Digimatic Holtest is a three-point internal micrometer with digital display (LCD).

Functions include: Zero-setting, Preset, Data Hold, Inch/mm conversion, Error alarm, Data output.

FEATURES

- TiN coated anvils for longer wear life
- Efficient measurement using two measurement modes—ABS (absolute) and INC (incremental) modes.
- The 468 Series provides digital readout to .00005"/0.001mm and can be linked to the M-SPC (Mitutoyo Statistical Process Control) system.
- Certificate of Inspection provided.



Order No.	Range	LCD Resolution	Graduation Thimble	List Price	Sale Price
468-261	.275-.350"/6.925-8.89mm	.00005"/0.001mm	.0002"	\$957.00	\$910.00
468-262	.35-.425"/8.89-10.795mm	.00005"/0.001mm	.0002"	\$957.00	\$910.00
468-263	.425-.5"/10.795-12.7mm	.00005"/0.001mm	.0002"	\$967.00	\$919.00
468-264	.5-.65"/12.7-16.51mm	.00005"/0.001mm	.0002"	\$1,070.00	\$1,017.00
468-265	.65-.8"/16.51-20.32mm	.00005"/0.001mm	.0002"	\$1,070.00	\$1,017.00
468-266	.8-1"/20.32-25.4mm	.00005"/0.001mm	.0002"	\$1,090.00	\$1,036.00
468-267	1-1.2"/25.4-30.48mm	.00005"/0.001mm	.0002"	\$1,090.00	\$1,036.00
468-268	1.2-1.6"/30.48-40.64mm	.00005"/0.001mm	.0002"	\$1,110.00	\$1,055.00
468-269	1.6-2"/40.64-50.8mm	.00005"/0.001mm	.0002"	\$1,120.00	\$1,064.00
468-270	2-2.5"/50.8-63.5mm	.00005"/0.001mm	.0002"	\$1,210.00	\$1,150.00
468-271	2.5-3.0"/63.5-76.2mm	.00005"/0.001mm	.0002"	\$1,210.00	\$1,150.00
468-272	3.0-3.5"/76.2-88.9mm	.00005"/0.001mm	.0002"	\$1,230.00	\$1,169.00
468-273	3.5-4.0"/88.9-101.6mm	.00005"/0.001mm	.0002"	\$1,240.00	\$1,178.00



Order No.	Description	List Price	Sale Price
05CZA662	40" IP65 Holtest Cable	\$72.55	\$69.00
05CZA663	80" IP65 Holtest Cable	\$80.00	\$76.00

Bore Gages



Borematic w/Absolute Technology Encoder



FEATURES

- TiN coated anvils for longer wear life
- LCD Resolution .00005"/0.001mm.
- Efficient measurement using two measurement modes—ABS (absolute) and INC (incremental) modes.
- Can be linked to the M-SPC (Mitutoyo Statistical Process Control) System.
- Certificate of Inspection provided.
- Measuring force (per anvil) – 10-30N
- Range/Accuracy: .5–.8"/±.0025", .8–4"/±.0003"



TiN coated anvils for longer wear life

Order No.	Range	Resolution	List Price	Sale Price
568-434-10	.5-.65"/12.7-16.51mm	.00005"/0.001mm	\$1,280.00	\$1,216.00
568-435-10	.65-.8"/16.51-20.32mm	.00005"/0.001mm	\$1,230.00	\$1,169.00
568-436-10	.8-1"/20.32-25.4mm	.00005"/0.001mm	\$1,280.00	\$1,216.00
568-437-10	1-1.2"/25.4-30.48mm	.00005"/0.001mm	\$1,330.00	\$1,264.00
568-438-10	1.2-1.6"/30.48-40.64mm	.00005"/0.001mm	\$1,470.00	\$1,397.00
568-439-10	1.6-2"/40.64-50.8mm	.00005"/0.001mm	\$1,470.00	\$1,397.00



Order No.	Description	List Price	Sale Price
937387	40" Borematic Cable	\$43.95	\$42.00
965013	80" Borematic Cable	\$51.90	\$49.00

Dial Bore Gages

FEATURES

- Interchangeable anvils and necessary accessories to perform close tolerance I.D. measurements.
- Carbide ball contact point for durability.
- Optional extension rods can be attached.
- A Digimatic Indicator can be attached in place of the dial gage.
- Accuracy: .0002"/5µm

Order No.	Graduation (Indicator)	Measuring Range	Probe Depth	List Price	Sale Price
511-163	.0001" (2923SB-10)	.7-1.4"	4"	\$356.00	\$339.00
511-164	.0001" (2923SB-10)	1.4-2.5"	6"	\$348.00	\$331.00
511-166	.0001" (2923SB-10)	2-6"	6"	\$380.00	\$361.00

511-166



Tubular Inside Micrometers

FEATURES

- Wide range of ID measurements by combining extension pipes and anvils with the micrometer head.
- Supplied in fitted case.

Order No.	Graduation	Measuring Range	List Price	Sale Price
139-201	.001"	1.5 - 12"	\$226.00	\$215.00
139-202	.001"	4 - 40"	\$342.00	\$325.00



139-201

Depth Gages



Depth Micrometers

FEATURES

- Interchangeable rods, with lapped measuring end, provide a wide measuring range.
- The rod length can be interchanged in 1" increments.
- With ratchet stop for constant force.
- With measuring rod clamp.
- With SPC output (Series 329).
- Supplied in fitted plastic case.



329-350

Order No.	Range	Graduation Resolution	Remarks	List Price	Sale Price
Mechanical Style					
129-127	0-4"	.001"	2.5" Base	\$162.00	\$154.00
129-131	0-4"	.001"	4" Base	\$179.00	\$171.00
Digimatic Style					
329-350-10	0-6"/0-150mm	.00005"/0.001mm	4" Base	\$512.00	\$487.00



129-127



Order No.	Description	List Price	Sale Price
05CZA662	40" Depth Mic Cable	\$72.55	\$69.00
05CZA663	80" Depth Mic Cable	\$80.00	\$76.00

ABSOLUTE Digimatic Depth Gage

FEATURES

- ABSOLUTE Digimatic Depth Gage can keep track of the origin point once set for the entire life of the battery.
- Base and measuring faces are hardened and micro-lapped.
- Optional wider extension base are available.
- With SPC data output.



571-263-10



571-264-10

New!



Order No.	Range	Resolution	List Price	Sale Price
571-261-10	0-6"/0-150mm	.0005"/0.01mm	\$428.00	\$407.00
571-262-10	0-8"/0-200mm	.0005"/0.01mm	\$475.00	\$452.00
571-263-10	0-12"/0-300mm	.0005"/0.01mm	\$495.00	\$471.00
Hook End Type				
571-264-10	0-6"/0-150mm	.0005"/0.01mm	\$440.00	\$418.00
571-265-10	0-8"/0-200mm	.0005"/0.01mm	\$485.00	\$461.00

Order No.	Description	List Price	Sale Price
05CZA624	40" IP Caliper Cable	\$81.30	\$78.00
05CZA625	80" IP Caliper Cable	\$82.50	\$79.00

Digimatic Depth Gage

FEATURES

- ABSOLUTE Digimatic Depth Gage can keep track of the origin point once set for the entire life of the battery.
- Wide probing range is available with the supplied extension rod.
- Bottom surface of the 2.5" base is hardened, ground and lapped for flatness.
- With SPC data output.



Order No.	Range	Graduation	List Price	Sale Price
547-217	0-8"/0-200mm	0.0005"/0.01mm	\$417.00	\$397.00



Order No.	Description	List Price	Sale Price
905338	40" Depth Gage Cable	\$34.60	\$32.00
905409	80" Depth Gage Cable	\$41.25	\$38.00

Tire Tread Depth Gage

FEATURES

- Specially designed to measure tire tread depth
- Plastic construction for light-weight use
- Inch/Metric conversion



700-105

Order No.	Range	Graduation	List Price	Sale Price
700-105	0-1"/0-25.4mm	.001"/0.1mm	\$65.05	\$62.00

Thickness Gages



Quick Mini



Quick Mini is a convenient snap-action pocket thickness gage offering LCD digital readout. Quick Mini is ideal for rapid checking of a wide variety of materials including metal, paper, plastics and wood.

Order No.	Measuring Range	Resolution	List Price	Sale Price
700-118	0-.5"/0-12.7mm	.0005"/0.01mm	\$103.00	\$98.00

Pocket Thickness Gage

A very compact thickness gage designed for carrying convenience and is ideally suited for quick inspection of paper, leather, wire, plastic, sheet metal and similar materials. The spindle is pre-loaded to provide a constant measuring force (2N or less).

FEATURES

- Measuring faces are hardened, ground and lapped for accuracy.
- Easy adjustment for zero point.

Order No.	Measuring Range	Graduation	List Price	Sale Price
7308	0-.4"	.001"	\$147.00	\$140.00
7309	0-10mm	0.01mm	\$147.00	\$140.00

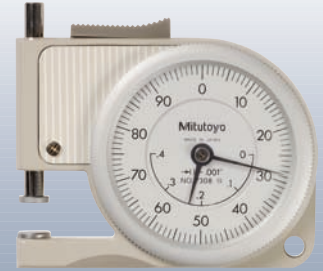

Dial Thickness Gage

FEATURES

- The Thickness Gage offers a quick and efficient means of inspection with their convenient grip handle, thumb trigger and spring-loaded spindle.
- The model covers a wide range of applications.
- With ceramic spindle and anvil

Order No.	Range	Graduation	List Price	Sale Price
73005	0-.5"	.001"	\$115.00	\$110.00



Digimatic Thickness Gages

The Thickness Gages offer a quick and efficient means of inspection with their convenient grip handle, thumb trigger and spring-loaded spindle. The various models cover a wide range of applications.

547-500: Ceramic anvil and spindle

547-520: Deep throat (4.7") with Ceramic anvil and spindle

547-400S: Hi-Res model with Ceramic anvil and spindle



547-520



547-500



547-400S

Order No.	Range	Resolution	List Price	Sale Price
547-500	0-.47"/0-12mm	.0005"/0.01mm	\$244.00	\$232.00
547-520	0-.47"/0-12mm	.0005"/0.01mm	\$264.00	\$251.00
547-400S	0-.47"/0-12mm	.00005"/.0001"/.0005" /0.001mm/0.01mm	\$720.00	\$684.00



Order No.	Description	List Price	Sale Price
905338	40" Thickness Gage Cable	\$34.60	\$32.00
905409	80" Thickness Gage Cable	\$41.25	\$38.00

Height Gages



New Series 192 Digimatic Height Gages

Now with two resolutions and two value preset memory and increased character height for easier viewing. The Heavy Duty Style has a built in touch probe port for the optional touch probe listed below.

Functions include:

- Zero/ABS setting (ABS and INC modes)
- 2 Value Preset Memory
- Data hold/data output
- \pm Counting
- Inch/mm conversion

Order No.	Range	Resolution	Accuracy	List Price	Sale Price
Standard Style with output					
192-630-10	0-12"/0-300mm	Switchable	\pm .001"	\$1,340.00	\$1,206.00
192-631-10	0-18"/0-450mm	.0005"/0.01mm	\pm .002"	\$1,830.00	\$1,647.00
192-632-10	0-24"/0-600mm	or	\pm .002"	\$2,330.00	\$2,097.00
192-633-10	0-40"/0-1000mm	.0002"/0.005mm	\pm .003"	\$4,410.00	\$3,969.00
Heavy Duty Style with output					
192-670-10	0-12"/0-300mm	Switchable	\pm .001"	\$1,530.00	\$1,377.00
192-671-10	0-18"/0-450mm	.0005"/0.01mm	\pm .0015"	\$1,980.00	\$1,782.00
192-672-10	0-24"/0-600mm	or	\pm .0015"	\$2,530.00	\$2,277.00
192-673-10	0-40"/0-1000mm	.0002"/0.005mm	\pm .0025"	\$4,750.00	\$4,275.00
Touch Probe for Heavy Duty Style Height Gage					
192-008	Bi-Directional touch probe		\$718.00	\$647.00	

New!



UP TO 10% OFF!



Order No.	Description	List Price	Sale Price
905338	40" Cable for Height Gage	\$34.60	\$32.00
905409	80" Cable for Height Gage	\$41.25	\$38.00

Digital Counter Type Height Gage

Double-column structure ensures high measuring accuracy. Coarse/Fine Feed switching. Carbide-tipped scriber.



Order No.	Range	Grad.	List Price	Sale Price
192-150	0-12"	.001"	\$880.00	\$792.00
192-151	0-18"	.001"	\$1,210.00	\$1,089.00
192-152	0-24"	.001"	\$1,580.00	\$1,422.00
192-153	0-40"	.001"	\$3,460.00	\$3,114.00

Heightmatic

FEATURES:

- .0001"/0.001mm resolution.
- \pm .0002"/ \pm 0.004mm accuracy.
- Functions: Zero-setting, Presetting, ABS/INC measurement mode switching, Data hold, Count direction switching, inch/mm conversion, Data output.
- Supplied with the bi-directional touch signal probe. The stylus tip ball diameter is automatically compensated for measurement.
- Fine feed wheel for the slider is provided on the base for easy operation.
- Provided with a data output port for connection with the SPC system.

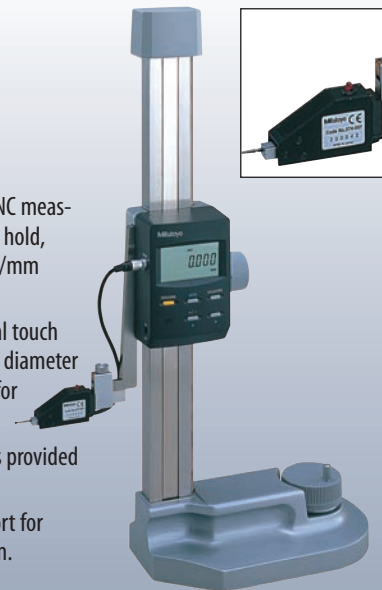

Order No.	Range	List Price	Sale Price
574-212-1A	0-12"/300mm	\$4,380.00	\$3,942.00
574-211-1A	0-18"/450mm	\$4,860.00	\$4,374.00
574-210-1A	0-24"/600mm	\$5,420.00	\$4,878.00

Height Gages



ABSOLUTE Digimatic Height Gage

FEATURES:

- Built in ABSOLUTE linear encoder. This encoder eliminates the necessity of setting the reference point at every power-on. It has improved reliability because no over-speed error will occur.
- Carbide-tipped scriber is provided.
- With SPC data output.

Order No.	Range	Resolution	Accuracy	List Price	Sale Price
570-312	0-12"/0-300mm	.0005"/0.01mm	±.0015"	\$544.00	\$490.00
570-313	0-18"/0-450mm	.0005"/0.01mm	±.002"	\$763.00	\$687.00
570-314	0-24"/0-600mm	.0005"/0.01mm	±.002"	\$983.00	\$885.00



QM-Height Series

The new world standard in height measurement!

Extreme accuracy, increased functionality and ease of use. The QM-Height delivers outstanding accuracy of $\pm(.00011 + .0002 \times L/40)$ " to satisfy your most critical measurement needs. It measures maximum/minimum and displacement from the surface or by increment. It also measures inside/outside diameter via a unique process (detect the circle apex and process by tracing measurement). Additionally, all the measurements can be saved and recalled after measurement.

Order No.	Range	Accuracy at 20°C	List Price	Sale Price
518-221	0-14"/0-350mm	$\pm(.00011 + .0002 \times L/40)$ " (L=Length in inches)	\$2,600.00	\$2,340.00
518-223	0-24"/0-600mm	$\pm(.00011 + .0002 \times L/40)$ " (L=Length in inches)	\$3,380.00	\$3,042.00
526688A	Linear Height AC Adapter		\$54.40	\$49.00



Linear Height LH-600D

The new Mitutoyo Linear Height LH-600D offers advanced performance for reliable and easy 2D measurement.

Measuring Range (stroke) 0-38"(24") / 0-972mm(600mm)

Order No.	Description	List Price	Sale Price
518-341A-21	Linear Height Gage	\$7,350.00	\$6,615.00
12AAA715	Linear Height Gage Setting Block	\$116.00	\$105.00



Input Tools & Cables



Digimatic Input Tools



FEATURES

- The input tool is an interface enabling you to easily input measurement data from a Mitutoyo measuring instrument with the digimatic output feature to your PC.
- An USB keyboard signal conversion input tool, converts measurement data to keyboard signals and directly inputs them to cells in off-the-shelf spreadsheet software such as Excel. An RS-232C communication input tool, is also available to input data through RS-232C communication.
- More accurate measurement is possible using an optional foot switch.

Digimatic Input Tools

Order No.	Description/Table Travel	List Price	Sale Price
264-005	Keyboard Input Tool	\$119.00	\$114.00
264-007	RS-232 Input Tool	\$241.00	\$229.00
264-012-10	USB Input Tool	\$171.00	\$163.00

Data Collection and Processor (DP-1VR)



DP-1VR with optional Digimatic Micrometer, Cable and Stand

Mitutoyo's DP-1VR is so compact, but with this powerful little device you can print data from your Digimatic caliper, micrometer and more using the Data Output function, and it can even calculate statistics.

\$418.00

Our Regular Price: \$439.00
Order Number: **264-504-5A**

Mitutoyo SPC Cables

Mitutoyo SPC cables for tools with Mitutoyo Digimatic SPC output.



Order No.	Length	Pins	For Use With	List Price	Sale Price
With Data Out Switch					
05CZA624	40"	—	IP66/67 Calipers	\$81.30	\$78.00
05CZA625	80"	—	IP66/67 Calipers	\$82.50	\$79.00
05CZA662	40"	—	IP65 Micrometers	\$72.55	\$69.00
05CZA663	80"	—	IP65 Micrometers	\$80.00	\$76.00
959149	40"	—	Height Gage 570 Series, Digimatic Indicator 543 and 575 Series, Digimatic Scale Unit 572 Series, Digimatic Absolute Calipers	\$43.65	\$42.00
959150	80"	—	Height Gage 570 Series, Digimatic Indicator 543 and 575 Series, Digimatic Scale Unit 572 Series, Digimatic Absolute Calipers	\$48.90	\$47.00
Without Data Out Switch					
937387	40"	6	Mic Heads 164 Series, Digimatic Holtest 468 Series, Borematic 568 Series	\$43.95	\$42.00
965013	80"	6	Mic Heads 164 Series, Digimatic Holtest 468 Series, Borematic 568 Series	\$51.90	\$49.00
905338	40"	—	Height Gage 570 Series, Digimatic Indicator 543 and 575 Series, Digimatic Scale Unit 572 Series	\$34.60	\$32.00
905409	80"	—	Height Gage 570 Series, Digimatic Indicator 543 and 575 Series, Digimatic Scale Unit 572 Series	\$41.25	\$38.00

Digimatic Indicators



IDC Digimatic Indicators

FEATURES

- Absolute Encoder ensures all settings and readings maintained for the life of the battery (even when the power is turned off).
- Preset, Zero-Set, inch/mm, +/- direction and GO/±NG functions.
- Face rotates 330° for use at various angles on some models.
- Stem diameter: .375"
- Immune to overspeed error.
- SPC output provided on some models.

New!

Order No.	Range	Remark	List Price	Sale Price
.0005"/0.01mm Resolution				
543-402	.500"/12.5mm	Lug Back	\$268.00	\$255.00
543-402B	.500"/12.5mm	Flat Back	\$268.00	\$255.00
543-406	.500"/12.5mm	Lug Back, Low Force	\$431.00	\$410.00
543-406B	.500"/12.5mm	Flat Back, Low Force	\$431.00	\$410.00
543-476B	1"/25mm	Flat Back	\$393.00	\$374.00
543-496B	2"/50mm	Flat Back	\$517.00	\$492.00
.00005"/.0001"/.0005"/0.001mm/0.01mm Resolution				
543-392	.500"/12.5mm	Lug Back	\$368.00	\$350.00
543-392B	.500"/12.5mm	Flat Back	\$368.00	\$350.00
543-396	.500"/12.5mm	Lug Back, Low Force	\$575.00	\$547.00
543-396B	.500"/12.5mm	Flat Back, Low Force	\$575.00	\$547.00
543-472B	1"/25mm	Flat Back	\$492.00	\$468.00
543-492B	2"/50mm	Flat Back	\$618.00	\$588.00
Max/Min Hold Function				
543-262	.5"/12.7mm	w/max/min, Lug Back	\$435.00	\$392.00
543-262B	.5"/12.7mm	w/max/min, Flat Back	\$435.00	\$392.00
543-263	.5"/12.7mm	w/max/min, Lug Back	\$435.00	\$392.00
543-263B	.5"/12.7mm	w/max/min, Flat Back	\$435.00	\$392.00
Bore Gage Applications				
543-266B	.5"/12.7mm	Flat Back	\$435.00	\$392.00
Signal IDC				
543-282	.5"/12.7mm	.00005"/0.001mm, Lug Back	\$491.00	\$442.00
543-282B	.5"/12.7mm	.00005"/0.001mm, Flat Back	\$491.00	\$442.00



Order No.	Description	List Price	Sale Price
905338	40" Cable for Indicators	\$34.60	\$32.00
905409	80" Cable for Indicators	\$41.25	\$38.00

IDS Digimatic Indicators with Absolute Encoder



Functions:

Origin-set, Zeroset, ± Counting, Power ON/OFF, Data output, inch/mm conversion

Order No.	Range	Resolution	Remarks	List Price	Sale Price
543-683	0-.5"/0-12.7mm	.0005"/0.01mm	Lug Back	\$153.00	\$146.00
543-683B	0-.5"/0-12.7mm	.0005"/0.01mm	Flat Back	\$153.00	\$146.00
543-693	0-.5"/0-12.7mm	.0001"/0.001mm	Lug Back	\$236.00	\$225.00
543-693B	0-.5"/0-12.7mm	.0001"/0.001mm	Flat Back	\$236.00	\$225.00
543-692	0-.5"/0-12.7mm	.00005"/0.001mm	Lug Back	\$236.00	\$225.00
543-692B	0-.5"/0-12.7mm	.00005"/0.001mm	Flat Back	\$236.00	\$225.00
543-696	0-.5"/0-12.7mm	.00005"/0.001mm	Lug Back, Dust Proof	\$261.00	\$248.00
543-696B	0-.5"/0-12.7mm	.00005"/0.001mm	Flat Back, Dust Proof	\$261.00	\$248.00
543-691	0-.5"/0-12.7mm	.00005"/0.001mm	Lug Back, 8mm Stem	\$244.00	\$232.00
543-691B	0-.5"/0-12.7mm	.00005"/0.001mm	Flat Back, 8mm Stem	\$244.00	\$232.00

Order No.	Description	List Price	Sale Price
905338	40" Cable for Indicators	\$34.60	\$32.00
905409	80" Cable for Indicators	\$41.25	\$38.00



Digimatic Indicators



ID-H Digimatic Indicator

FEATURES

- Long Stroke and high accuracy
- High Resolution
- Special function applications such as TIR or Max/Min
- Infrared Remote Control (optional)
- Large LCD for easy to read Go/No-Go (Green/Red) applications
- SPC output and RS-232C I/O



ABSOLUTE™

Absolute System Patented by MITUTOYO

Optional Infra-red remote
Part No. 21EZA099
List Price \$80.00
Sale Price \$76.00



Order No.	Range	Accuracy	List Price	Sale Price
Resolution: .00002"/.00005"/.0001"/0.0005mm/0.001mm				
543-562A	1.2"/30mm	.00006"/0.0015mm	\$765.00	\$689.00
543-564A	2.4"/60mm	.0001"/0.0025mm	\$908.00	\$818.00
21EZA099	Optional Infra-red remote		\$80.00	\$72.00

IDF Indicators

ABSOLUTE™

Absolute System Patented by MITUTOYO



543-552A



543-558A

Order No.	Range	Resolution	List Price	Sale Price
543-552A	1"/25.4mm	.00005", .0001", .0005", .001", 0.001mm, 0.01mm	\$579.00	\$522.00
543-558A	2"/50.8mm	.00005", .0001", .0005", .001", 0.001mm, 0.01mm	\$670.00	\$603.00



Order No.	Description	List Price	Sale Price
936937	SPC cable (40"/1m)	\$41.35	\$38.00
965014	SPC cable (80"/2m)	\$48.35	\$44.00

ID-N (Narrow) Digimatic Indicator

FEATURES

- Absolute Encoder ensures all settings and readings maintained for the life of the battery (even when the power is turned off).
- IP-66 level of protection.
- Small 1.38" (35mm) width is an ideal advantage for multiple gage applications
- Multi-direction viewing is possible by the reversible LCD display.
- Measurement fixtures for various applications can be constructed with the combination of ID-N and ID-B indicators.
- For SPC, order cable 21EAA194 40" (1m) or 21EAA190 80" (2m)



ID-N Order No.	Range	Resolution	Accuracy	List Price	Sale Price
543-571	.5"/12.7mm	.0005"/0.01mm	.0008"/0.02mm	\$313.00	\$282.00
543-576	.5"/12.7mm	.00005"/0.001mm .0005"/0.01mm	.00012"/0.003mm	\$434.00	\$391.00

ID-B Order No.	Range	Resolution	Accuracy	List Price	Sale Price
543-581	.2"/5.08mm	.0005"/0.01mm	.0008"/0.02mm	\$345.00	\$311.00
543-586	.2"/5.08mm	.00005"/0.001mm .0005"/0.01mm	.00012"/0.003mm	\$467.00	\$421.00

ID-B (Back-plunger) Digimatic Indicator

ABSOLUTE™

Absolute System Patented by MITUTOYO



IDU Digimatic Indicator with Absolute Encoder

FEATURES

- Compact and economical design.
- Provided with a data output port for connection with the SPC system.
- Operating temperature: 0°C–40°C
- Membrane sealed face helps keep out contaminants.
- 0–1"/0–25.4mm measuring range
- .0005"/0.01mm resolution
- .0008" accuracy (20°C)



\$153.00

Our Regular Price: \$169.00
Order Number: 575-123

ABSOLUTE™

Absolute System Patented by MITUTOYO

Order No.	Description	List Price	Sale Price
905338	40" Indicator Cable	\$34.60	\$32.00
905409	80" Indicator Cable	\$41.25	\$38.00



Indicators



Series Zero/ One Dial Indicators

Order No.	Graduation	Range	Accuracy	Dial Reading	List Price	Sale Price
Series One						
1410F	.001"	.25"	±.001"	0-100	\$93.35	\$89.00
1410S-10**	.001"	.25"	±.001"	0-100	\$97.05	\$93.00
1410FB*	.001"	.25"	±.001"	0-100	\$93.35	\$89.00
1411F	.001"	.25"	±.001"	0-50-0	\$93.35	\$89.00
1411FB*	.001"	.25"	±.001"	0-50-0	\$93.35	\$89.00
1506S	.0005"	.125"	±.0005"	0-50	\$86.40	\$83.00
1506SB*	.0005"	.125"	±.0005"	0-50	\$86.40	\$83.00
1507S	.0005"	.125"	±.0005"	0-25-0	\$86.40	\$83.00
1507SB*	.0005"	.125"	±.0005"	0-25-0	\$86.40	\$83.00
1803S-10**	.0001"	.025"	±.0001"	0-5-0	\$145.00	\$138.00
1803SB-10***	.0001"	.025"	±.0001"	0-5-0	\$145.00	\$138.00
Series Zero						
1925-10**	.0001"	.025"	±.0002"	0-5-0	\$139.00	\$133.00
1925B-10***	.0001"	.025"	±.0002"	0-5-0	\$139.00	\$133.00

* with flat back ** jeweled ***jeweled and flat back



Series One Dial Indicator



Back Plunger Indicator with Perpendicular Stem

Order No.	Range	Graduation	Accuracy	Dial Face	List Price	Sale Price
1156	.1"	.001"	±.001"	0-100	\$113.00	\$108.00
1157	.1"	.001"	±.001"	0-50-0	\$113.00	\$108.00

New Dial Indicator

Order No.	Graduation	Range	Dial Face	Accuracy	Remarks	List Price	Sale Price
Series Two Dial Indicators							
2410S	.001"	.25"	0-100	±.001"		\$89.05	\$85.00
2410S-10	.001"	.25"	0-100	±.001"	Jeweled	\$104.00	\$99.00
2410S-60	.001"	.25"	0-100	±.001"	Jeweled, Water Proof	\$132.00	\$126.00
2414S	.001"	.5"	0-100	±.001"		\$95.45	\$91.00
2414S-10	.001"	.5"	0-100	±.001"	Jeweled	\$109.00	\$104.00
2414S-60	.001"	.5"	0-100	±.001"	Waterproof	\$131.00	\$125.00
2416S	.001"	1"	0-100	±.002"		\$107.00	\$102.00
2416SB*	.001"	1"	0-100	±.002"		\$107.00	\$102.00
2416S-10	.001"	1"	0-100	±.002"	Jeweled	\$122.00	\$116.00
2416SB-10*	.001"	1"	0-100	±.002"	Jeweled	\$122.00	\$116.00
2416S-60	.001"	1"	0-100	±.001"	Waterproof	\$143.00	\$136.00
2424S-19	.001"	2"	0-100	±.003"	Jeweled, Shock Proof	\$191.00	\$182.00
2803S-10	.0001"	.025"	0-5-0	±.0002"	Jeweled, Shock Proof	\$139.00	\$133.00
2803SB-10*	.0001"	.025"	0-5-0	±.0002"	Jeweled, Shock Proof	\$139.00	\$133.00
2804S-10	.0001"	.05"	0-10	±.0002"	Jeweled, Shock Proof	\$143.00	\$136.00
2804SB-10*	.0001"	.05"	0-10	±.0002"	Jeweled, Shock Proof	\$143.00	\$136.00
2358S-10	.0001"	.5"	0-10	±.0002"	Jeweled	\$191.00	\$182.00
2358SB-10*	.0001"	.5"	0-10	±.0002"	Jeweled	\$191.00	\$182.00
2046S**	0.01mm	10mm	0-100	±0.013mm		\$99.20	\$95.00
2046S-01	0.01mm	10mm	0-100	±0.013mm		\$77.90	\$75.00
2109S-10**	0.001mm	1mm	0-100-0	±0.005mm	Jeweled	\$174.00	\$166.00

* Flat Back, ** 8mm Stem

Mitutoyo's Dial Gages now offer users more stability and longer life, thanks to advances to the inner workings of the rack and pinion gear system. Shock resistance is increased with a more robust gear train, while contamination resistance has been dramatically increased over other indicators of this type with a tighter seal around the bezel and frame, and the elimination of a lifting lever screw.



Series Two One Revolution Dial Indicators

Unlike many other dial indicators, the one revolution dial indicator shows the entire spindle travel or range as one sweep of the hand, eliminating the possibility of reading errors due to miscounting the multiple revolutions. With one-revolution dial indicators, "within tolerance" and "out-of tolerance" can not be misinterpreted.

Order No.	Range	Graduation	Dial Reading	Remarks	List Price	Sale Price
2976*	.02"	.0005"	10-0-10	3/8" Stem	\$70.45	\$67.00
2977*	.04"	.0005"	20-0-20	3/8" Stem	\$58.70	\$56.00
2978*	.06"	.001"	30-0-30	3/8" Stem	\$64.05	\$61.00
2971*	0.5mm	0.01mm	25-0-25	8mm Stem	\$70.45	\$67.00
2972*	1mm	0.01mm	50-0-50	8mm Stem	\$58.15	\$56.00
2973*	1.6mm	0.02mm	80-0-80	8mm Stem	\$63.45	\$61.00

* Flat Back

Indicator Sets



“Quick-Set” Test Indicators

The most direct gear train design ever applied to Test Indicators means— higher levels of sensitivity, reliability, repeatability and accuracy throughout tool life.

FEATURES

- Anti-magnetic
- Jeweled bearings
- No-clutch structure
- Water and dust resistant
- Glare-free crystal with scratch-resistant coating
- Metric dial faces in yellow
- Measuring force 0.3N or less



Inch Test Indicators and Sets

Order No.	Graduation	Range	Dial Face	Remarks	List Price	Sale Price
513-402	.0005"	.03"	0-15-0	Basic Set	\$113.00	\$108.00
513-402T	.0005"	.030"	0-15-0	Full Set	\$134.00	\$128.00
513-412	.0005"	.030"	0-15-0	Long Point Basic Set	\$161.00	\$153.00
513-412T	.0005"	.030"	0-15-0	Long Point Full Set	\$186.00	\$177.00
513-403	.0001"	.008"	0-4-0	Basic Set	\$146.00	\$139.00
513-403T	.0001"	.008"	0-4-0	Full Set	\$172.00	\$164.00

Combitec Set Inch/Metric

513-406	.0005"/0.01mm	.030"/0.7mm	0-15-0/0-35-0	Basic Set	\$132.00	\$126.00
513-406T	.0005"/0.01mm	.030"/0.7mm	0-15-0/0-35-0	Full Set	\$146.00	\$139.00

Metric Test Indicators and Sets

513-404	0.01mm	0.8mm	0-40-0	Basic Set	\$122.00	\$116.00
513-404T	0.01mm	0.8mm	0-40-0	Full Set	\$135.00	\$129.00
513-405	0.002mm	0.2mm	0-100-0	Basic Set	\$147.00	\$140.00
513-405T	0.002mm	0.2mm	0-100-0	Full Set	\$166.00	\$158.00

Truetest Test Indicators

The most direct gear train design ever applied to Test Indicators means— higher levels of sensitivity, reliability, repeatability and accuracy throughout tool life.

FEATURES

- Smooth spindle movement for increase measuring accuracy
- 20° tilted dial face for easy reading
- Anti-magnetic characteristics
- With rev counter

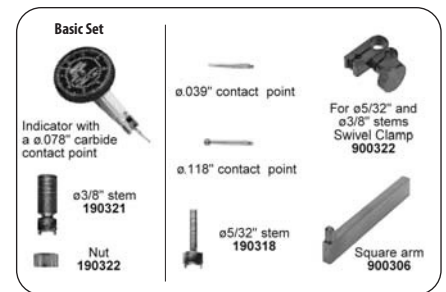

Inch Test Indicators and Sets

Order No.	Graduation	Range	Dial Face	Remarks	List Price	Sale Price
513-442	.0005"	.060"	0-15-0		\$152.00	\$145.00
513-442T	.0005"	.060"	0-15-0	Set	\$173.00	\$165.00
513-442-01	.0005"	.060"	0-15-0	Blue Face	\$152.00	\$145.00
513-442T-01	.0005"	.060"	0-15-0	Blue Face Set	\$173.00	\$165.00
513-442-06	.0005"	.060"	0-15-0	Black Face	\$152.00	\$145.00
513-442T-06	.0005"	.060"	0-15-0	Black Face Set	\$173.00	\$165.00
513-446	.0005"	.060"	0-15-0	Long Point	\$204.00	\$194.00
513-446T	.0005"	.060"	0-15-0	Long Point Set	\$230.00	\$219.00
513-446-06	.0005"	.060"	0-15-0	Long Point Black Face	\$204.00	\$194.00
513-443	.0001"	.016"	0-4-0		\$192.00	\$183.00
513-443T	.0001"	.016"	0-4-0	Set	\$217.00	\$207.00
513-443T-06	.0001"	.016"	0-4-0	Black Face Set	\$217.00	\$207.00



Universal Type Test Indicator

FEATURES

- The lower portion of the indicator can be rotated 360°
- No clutch structure for automatic reversal of measuring direction

Complete Set

Order No.	Range	Graduation	Dial Reading	Accuracy	List Price	Sale Price
513-302GT	.03"	.0005"	0-15-0	\pm .0005"	\$389.00	\$370.00
513-304GT	0.8mm	0.01mm	0-40-0	\pm 0.008mm	\$389.00	\$370.00
513-304GE*	0.8mm	0.01mm	0-40-0	\pm 0.008mm	\$356.00	\$339.00

* Basic Set

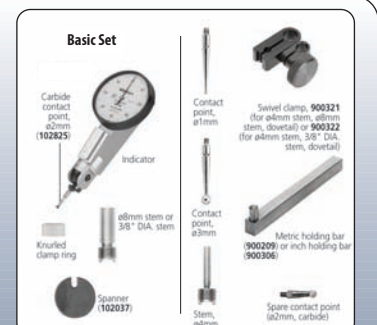

Bases and Stands



Indicator and Magnetic Base Set

FEATURES

- The 7045 Magnetic Base/Indicator Set has a 2804S-10, .05" travel, .0001" graduations dial indicator.
- The 7046 Magnetic Base/Indicator Set has a 2416S, 1" travel, .001" graduations dial indicator.
- Both sets have a 7010S magnetic base with 132 Lbf of magnet force with On/Off switch.

Order No.	Description	List Price	Sale Price
7045	Magnetic Base w/2804S-10 Dial Indicator	\$226.00	\$215.00
7046	Magnetic Base w/2416S Dial Indicator	\$203.00	\$193.00

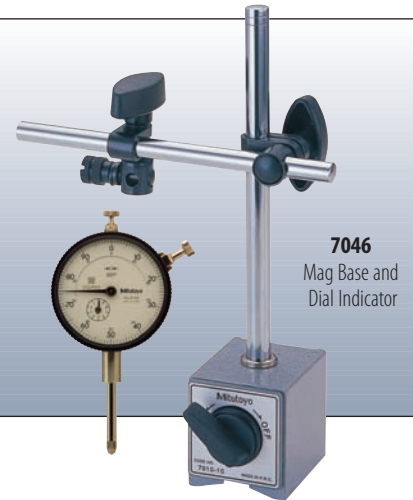

7046
Mag Base and
Dial Indicator

Magnetic Bases

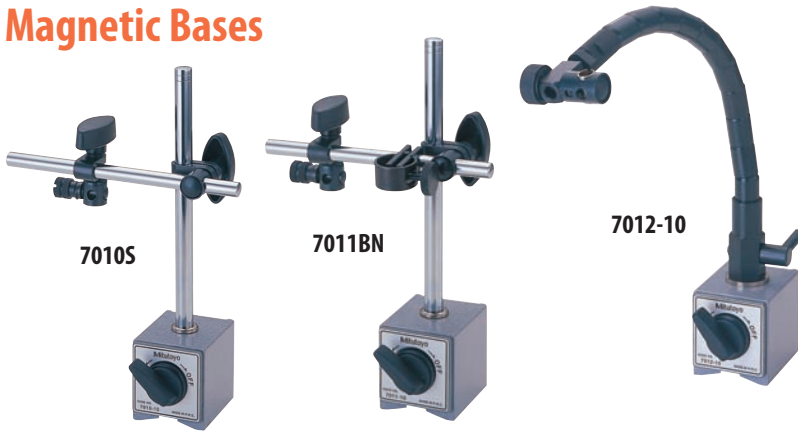

7010S

7011BN

7012-10

Mitutoyo Magnetic Stands accept all AGD-type dial indicators, test indicators and probes having .375", 6mm or 8mm diameter stems and/or lug back with 1/4" diameter mounting hole. The On/Off switch offers instant mounting and dismounting without any adverse effect to the indicators or work surface.

Mitutoyo Magnetic Stands have 132 Lbf of magnetic force to help prevent damage to indicators and probes due to accidental base fall-over.

Order No.	Description	List Price	Sale Price
7010S	Magnetic Stand w/6" Rod & Universal Clamp	\$120.00	\$114.00
7011BN	Magnetic Stand w/6" Adjustable Rod & Universal Clamp	\$137.00	\$131.00
7012-10	Flexible Magnetic Stand	\$175.00	\$167.00

Transfer Stand

The Transfer Stands are designed for comparison measurements of height using a dial indicator or Digimatic Indicator.

- Vertical travel of the gage holder –Dial Gage Stand: 320mm, Transfer Stand: 335mm
- Fine-adjustment of 1mm available for zero-setting of the indicator.
- With an interchangeable anvil. Domed anvil (101463) and Flat anvil(101461) are optional.



519-109E

Order No.	Stem Hole	Remarks	List Price	Sale Price
519-109E	3/8" DIA	w/serrated anvil	\$459.00	\$437.00

Dial Gage Stand

with Serrated Anvil

This Dial Gage Stand provides an ideal work base for all AGD type indicators as well as other gages with a .375" DIA. mounting stem.



7008

Order No.	Max. Height Capacity	Mounting Stem Dia.	List Price	Sale Price
7008	3.54"	.375"	\$304.00	\$289.00

Dial Gage Stand

with Flat or Serrated Anvil

The compact and versatile Dial Gage Stands are commonly used general-purpose stands for comparison measurements, 4" maximum height capacity. They feature a wide fine adjusting range for zero-setting gage heads.

For 3/8" diameter mounting stems.



7003

Order No.	Max. Height Capacity	Anvil Type	List Price	Sale Price
7003	4.0"	Serrated Anvil	\$305.00	\$290.00
7004	4.0"	Flat Anvil	\$307.00	\$292.00

Indicator Sets



Pocket Type Test Indicator Sets

FEATURES

- Jeweled bearings
- Reversible measuring direction
- Contact points adjustable within 220°
- Two holding bars supplied

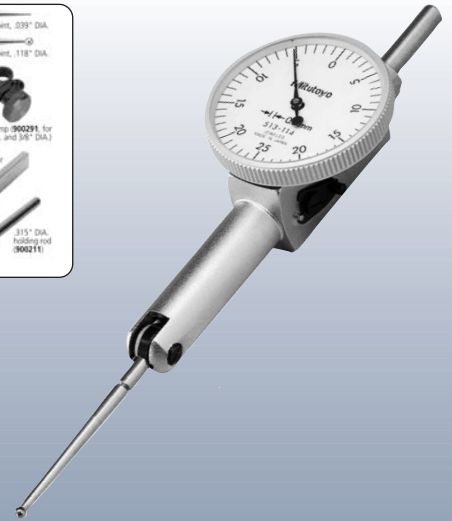

Complete Set

Order No.	Range	Graduation	Dial Face	Accuracy	List Price	Sale Price
513-504T	.01"	.0001"	0-5-0	±.0002"	\$152.00	\$145.00
513-512T**	.02"	.0005"	0-10-0	±.0005"	\$158.00	\$151.00
513-518T	.04"	.001"	0-20-0	±.001"	\$119.00	\$114.00
513-528T*	.04"	.001"	0-20-0	±.001"	\$125.00	\$119.00

* Compact Style, ** Long Point

TI with Ruby Stylus

FEATURES

- Wear characteristic improved by 50%.
- Non-magnetic and non-conductive material, enable its use in EDM operation

SPECIFICATIONS

Graduation: .0005"
 Measuring Range: .03"
 Dial Face: 0-15-0
 Accuracy: ±.0005"
 Measuring Force: .072N or less
 Contact Point diameter: .079"
 Stem diameter: 3/8"



\$119.00

Our Regular Price: \$125.00
 Order Number: 513-472

Precision Tool Kit



Dial Test Indicator 513-907

- Graduation .0005"
- Range .03"
- Dial Reading 0-15-0
- Jeweled bearings, Anti-magnetic
- 3/8" DIA. Stem

Mini Magnetic Stand

- Includes swivel clamp for 5/32" and 3/8" Dia. stems
- Swivel Clamp includes dovetail groove
- 150N Magnetic force

Complete with full one year warranty.

Dial Test Indicator 513-908

- Graduation 0.01mm
- Range 0.8mm
- Dial Reading 0-40-0
- Jeweled bearings, Anti-magnetic
- 8mm Stem

Mini Magnetic Stand

- Includes swivel clamp for ø6mm and ø8" Dia. stems
- Swivel Clamp includes dovetail groove
- 150N Magnetic force

Custom Tool Case

- Easy-Grip Handle
- Molded Tool Bed
- Durable Plastic Construction
- Convenient Storage



\$177.00

Order Number: 513-907 (Inch)
 Order Number: 513-908 (Metric)

Our Regular Price: \$186.00

Digimatic Micrometer Head for Toolmakers Microscopes



Order No.	Range	LCD Resolution	Accuracy	Remarks	List Price	Sale Price
164-162	0-2" 0-50.8mm	.00005" 0.001mm	±.00015"	Non-rotating spindle With SPC output	\$797.00	\$638.00

Order No.	Description	List Price	Sale Price
937387	40" Mic Head Cable	\$43.95	\$42.00
965013	80" Mic head Cable	\$51.90	\$49.00

Micrometer Heads



148-121



Standard small size make these mic heads convenient for many gage fixtures.

148 Series Small Size Standard Style Micrometer Heads

148-201



Extra small size make these mic heads fit where larger mic heads won't.

148 Series Ultra-Small/Small Size Style Micrometer Heads

153-301



Carbide faces on these mic heads reduce wear and increase mic head life.

153 Series Fine Graduation High Accuracy

UP TO 20% OFF!

150-802



The longer range make these mic heads great for wide range adjustment applications.

150 Series Mid Size Standard Style Micrometer Heads

Order No.	Graduation	Range	Stem DIA.	Stem	Spindle Face	Remarks	List Price	Sale Price
148 Series Small Size Standard Style Micrometer Heads								
148-122	.001"	0-.500"	.375"	with Clamp Nut and Spindle Lock	Flat		\$63.45	\$51.00
148-402	.001"	0-.500"	.375"	Plain	Flat		\$46.95	\$38.00
148-404	.001"	0-.500"	.375"	Plain with Spindle Lock	Flat		\$54.40	\$44.00
148-462	.001"	0-.500"	6mm	Plain	Flat		\$49.60	\$40.00
148-811	.001"	0-.500"	.375"	Plain	Spherical (SR4)		\$57.10	\$46.00
148-833	.001"	.500"-0	.375"	Plain with Spindle Lock	Flat	Reverse Reading	\$61.35	\$50.00
148-104	0.01mm	0-13mm	9.5mm	Plain	Flat		\$54.40	\$44.00
148-401	0.01mm	0-13mm	.375"	Plain	Flat		\$46.95	\$38.00
148-121	0.01mm	0-13mm	9.5mm	Plain with Spindle Lock	Flat		\$60.80	\$49.00
148-801	0.01mm	0-13mm	9.5mm	Plain	Spherical (SR4)		\$57.10	\$46.00
148-823	0.01mm	13mm-0	9.5mm	Plain with Spindle Lock	Flat	Reverse Reading	\$61.35	\$50.00
148 Series Ultra-Small/Small Size Style Micrometer Heads								
148-202	.001"	0-.250"	.250"	Plain	Flat		\$54.40	\$44.00
148-204	.001"	0-.250"	.250"	with Clamp Nut	Flat		\$56.00	\$45.00
148-206	.001"	0-.250"	.250"	Plain	Spherical (SR3)		\$56.00	\$45.00
148-208	.001"	0-.250"	.250"	with Clamp Nut	Spherical (SR3)		\$57.10	\$46.00
148-201	0.01mm	0-6.5mm	6mm	Plain	Flat		\$54.40	\$44.00
148-203	0.01mm	0-6.5mm	6mm	with Clamp Nut	Flat		\$56.00	\$45.00
148-205	0.01mm	0-6.5mm	6mm	Plain	Spherical (SR3)		\$56.00	\$45.00
148-207	0.01mm	0-6.5mm	6mm	with Clamp Nut	Spherical (SR3)		\$57.10	\$46.00
150 Series Mid Size Standard Style Micrometer Heads								
150-208	.001"	0-1"	.375"	Plain	Flat (Carbide Tip)		\$65.05	\$53.00
150-402	.001"	0-1"	.500"	Plain	Flat (Carbide Tip)		\$59.75	\$48.00
150-404	.001"	0-1"	.500"	Plain with Spindle Lock	Flat (Carbide Tip)		\$81.60	\$66.00
150-811	.001"	0-1"	.375"	Plain	Spherical (SR4)		\$66.65	\$54.00
150-812	.001"	0-1"	.375"	with Clamp Nut	Spherical (SR4)		\$69.85	\$56.00
150-192	0.01mm	0-25mm	10mm	Plain	Flat (Carbide Tip)		\$65.05	\$53.00
150-802	0.01mm	0-25mm	10mm	with Clamp Nut	Spherical (SR4)		\$69.85	\$56.00
151 Series Mid Size 8mm DIA. Spindle Micrometer Heads								
151-404	.001"	0-1"	.5625"	Plain with Spindle Lock	Flat (Carbide Tip)		\$98.15	\$79.00
151-412	.001"	0-2"	.500"	Plain	Flat (Carbide Tip)		\$139.00	\$112.00
151-401	0.01mm	0-25mm	.5625"	Plain	Flat (Carbide Tip)		\$85.35	\$69.00
151-403	0.01mm	0-25mm	.5625"	Plain with Spindle Lock	Flat (Carbide Tip)		\$127.00	\$102.00
153 Series Fine Graduation High Accuracy								
153-302	.00001"	0-1"	18mm	Plain	Flat (Carbide Tip)	Bidirectional Graduation	\$1,050	\$840.00
153-301	0.0005mm	0-25mm	18mm	Plain	Flat (Carbide Tip)	Bidirectional Graduation	\$1,050	\$840.00

Gage Blocks



Gage Block Sets

Order No.	Blocks/Set	Grade	Shape	Material	Size	Step	Qty	List Price	Sale Price
516-903-26PRO	81	AS-1	RECT	STEEL	.1001" - .1009"	0.0001"	9	\$1,480	\$1,184
					.101" - .149"	0.001"	49		
					.05" - .95"	0.05"	19		
					1" - 4"	1"	4		
516-303-26PRO	81	AS-1	RECT	CERA	.1001" - .1009"	0.0001"	9	\$3,050	\$2,440
					.101" - .149"	0.001"	49		
					.05" - .95"	0.05"	19		
					1" - 4"	1"	4		
516-403-26PRO	81	AS-1	SQUARE	STEEL	.1001" - .1009"	0.0001"	9	\$2,180	\$1,744
					.101" - .149"	0.001"	49		
					.05" - .95"	0.05"	19		
					1" - 4"	1"	4		
516-203-26PRO	81	AS-1	SQUARE	CERA	.1001" - .1009"	0.0001"	9	\$3,470	\$2,776
					.101" - .149"	0.001"	49		
					.05" - .95"	0.05"	19		
					1" - 4"	1"	4		
516-127-26PRO	8	AS-1	RECT	STEEL	1" - 8"	1"	8	\$999	\$800
516-713-26PRO	8	AS-1	RECT	STEEL	5", 6", 7"	1"	3	\$3,070	\$2,456
					8", 10", 12"	2"	3		
					16", 20"	4"	2		
516-743-26PRO	8	AS-1	RECT	CERA	5", 6", 7"	1"	3	\$9,050	\$7,240
					8", 10", 12"	2"	3		
					16", 20"	4"	2		
516-763-26PRO	8	AS-1	SQUARE	STEEL	5", 6", 7"	1"	3	\$3,480	\$2,784
					8", 10", 12"	2"	3		
					16", 20"	4"	2		



Square Steel Gage Block Set



Rectangular Steel Gage Block Set



Individual Inch Gage Blocks

FEATURES

- If using only one length repeatedly, it is a good idea to purchase discrete gage blocks.
- Each gage block is supplied with a Certificate of Inspection.

UP TO 20% OFF!



Order No.	Grade	Size	Shape	Material	List Price	Sale Price
611310-541PRO	AS-1	0.010"	RECT	STEEL	\$75.75	\$61.00
611320-541PRO	AS-1	0.020"	RECT	STEEL	\$34.70	\$28.00
611325-541PRO	AS-1	0.025"	RECT	STEEL	\$34.70	\$28.00
611326-541PRO	AS-1	0.026"	RECT	STEEL	\$34.70	\$28.00
611330-541PRO	AS-1	0.030"	RECT	STEEL	\$34.70	\$28.00
611118-541PRO	AS-1	0.180"	RECT	STEEL	\$16.55	\$14.00
611119-541PRO	AS-1	0.190"	RECT	STEEL	\$16.55	\$14.00
611194-541PRO	AS-1	0.40"	RECT	STEEL	\$19.25	\$16.00
611202-541PRO	AS-1	2.0"	RECT	STEEL	\$43.75	\$35.00
611203-541PRO	AS-1	3.0"	RECT	STEEL	\$52.30	\$42.00
611204-541PRO	AS-1	4.0"	RECT	STEEL	\$59.20	\$48.00
611206-541PRO	AS-1	6.0"	RECT	STEEL	\$203.00	\$163.00
611222-541PRO	AS-1	10"	RECT	STEEL	\$336.00	\$269.00
611223-541PRO	AS-1	12"	RECT	STEEL	\$402.00	\$322.00
613165-541PRO	AS-1	0.125"	RECT	CERA	\$34.15	\$28.00

Order No.	Grade	Size	Shape	Material	List Price	Sale Price
613212-541PRO	AS-1	0.25"	RECT	CERA	\$57.10	\$46.00
614320-541PRO	AS-1	0.020"	SQUARE	STEEL	\$43.75	\$35.00
614106-541PRO	AS-1	0.060"	SQUARE	STEEL	\$29.90	\$24.00
614191-541PRO	AS-1	0.100"	SQUARE	STEEL	\$23.50	\$19.00
614166-541PRO	AS-1	0.126"	SQUARE	STEEL	\$23.50	\$19.00
614180-541PRO	AS-1	0.140"	SQUARE	STEEL	\$23.50	\$19.00
614212-541PRO	AS-1	0.25"	SQUARE	STEEL	\$28.80	\$24.00
614193-541PRO	AS-1	0.30"	SQUARE	STEEL	\$28.80	\$24.00
614213-541PRO	AS-1	0.35"	SQUARE	STEEL	\$28.80	\$24.00
614199-541PRO	AS-1	0.90"	SQUARE	STEEL	\$40.55	\$33.00
614201-541PRO	AS-1	1.0"	SQUARE	STEEL	\$40.55	\$33.00
614205-541PRO	AS-1	5.0"	SQUARE	STEEL	\$242.00	\$194.00
614206-541PRO	AS-1	6.0"	SQUARE	STEEL	\$280.00	\$224.00
614208-541PRO	AS-1	8.0"	SQUARE	STEEL	\$327.00	\$262.00
616183-541PRO	AS-1	0.143"	SQUARE	CERA	\$46.95	\$38.00

Laser Micrometers



LSM-9506 Bench-Top Type Laser Scan Micrometer with display



Measuring Range	.02 - 2.36" (0.5 - 60mm)
Measuring Area	.02 x 2.36" (5x60mm) (*1)
Scanning Rate	1600/sec.
Resolution(Selectable)	.00002 - .005" (0.05 - 100µm)
Repeatability	±.00003"(±0.6µm) (±2σ measuring rate: 0.32s)
Accuracy	Linearity (*2) ±.0001" (±2.5µm) The optical axis direction ±.0001" (±2.5µm) The scanning direction ±(.00008+L/10000)" [L: inch] (*3) ±(2.0+L/10)µm [L:mm] (*3)

\$6,975⁰⁰

Our List Price: \$7,750.00
Order Number: **544-116-1A**

Laser Type	Visible semiconductor laser Wavelengths: 670nm Scanning speed: 8900"/s (226m/s)
Display	Fluorescent display 16-digit+11-digit, guidance LEDs
Measuring Function	Segment Designation: 1 to 7 (1 to 3 for Transparent) 10 Program Storage (PROG. 0 to PROG. 9) 255 Edge Designations can be detected Multi-Limit GO/±NG Tolerance Judgment (up to 7 intervals) Dual-Axis LED Display Offset Setting and Mastering Reference Value Setting Automatic Workpiece Detection Dual-Gage Calibration Inch/mm Conversion Abnormal Data Elimination Dual Program Measurement Statistical Processing Workpiece Position Display Foot-switch Connector

Data Output	Standard RS-232C, I/O Analog Interface, SPC
-------------	---

(*1): The area given by [measuring range on the optical axis] x [measuring range in the scanning direction].
(*2): Specified at the center of the measurement region.
(*3): L=Deviation between the center of workpiece and the optical axis.

LSM-500S

Mitutoyo's LSM-500S Series Laser Micrometers have the highest scanning speed in the world. A speed of 3,200 scans/sec makes in line measurements more accurate and repeatable. It's memory function has been increased to allow storage of up to 100 programs and includes a built in program to measure odd fluted drills and endmills.



(Entire Range)

Order No	Model	Range Inch	Range mm	Repeatability	Linearity	Scanning Rate	List Price	Sale Price
544-532*	LSM-500S	.0002" - .08"	0.005~2mm	±0.03µm	±0.3µm	3,200 scans/sec	\$6,150.00	\$5,535.00
544-534*	LSM-501S	.002" - .4"	0.05~10mm	±0.04µm	±0.5µm	3,200 scans/sec	\$5,240.00	\$4,716.00
544-536*	LSM-503S	.012" - 1.18"	0.3~30mm	±0.11µm	±1.0µm	3,200 scans/sec	\$5,920.00	\$5,328.00
544-538*	LSM-506S	.04" - 2.36"	1~60mm	±0.36µm	±3µm	3,200 scans/sec	\$7,110.00	\$6,399.00
544-540*	LSM-512S	.04" - 4.72"	1~120mm	±0.85µm	±6µm	3,200 scans/sec	\$12,400.00	\$11,160.00
544-496A**	LSM-902	.004" - 1.0"	0.1~25mm	±0.05µm	±0.5µm	800/sec	\$10,700.00	\$9,630.00

*LSM-6200 display unit is required. Order No. 544-072A

**LSM-6200 display unit is included

544-072A	LSM-6200 Display Unit						\$2,840.00	\$2,556.00
----------	-----------------------	--	--	--	--	--	------------	-------------------

Hardness Testers



HH-411 Hardmatic

Rebound type portable hardness tester featuring reproducibility and ease of operation on large parts. It is light weight and can be conveniently carried into the shop or out in the field.

\$3,888⁰⁰

Our List Price: \$4,320.00
Order Number: **810-298**



Model	HH-411		
Order No.	810-298		
Hardness Range	L-Value (ASTM A956)		
Detector	Input device D (carbide ball)		
	Hardness	Range	Resolution
	HL	1-999 HL	1 HL
	HV	43-950 HV	1 HV
	HB	20-894 HB	1 HB
Display	HRC	19.3-68.2 HRC	0.1 HRC
	HRB	13.5 - 101.7 HRB	0.1 HRB
	HS	13.2 - 99.3 HS	0.1 HS
	HTN	499 - 1996 Mpa	1 Mpa
Functions	Conversions: HL, HV, HB, HRC, HRB, HS, HTN Judgment: OK/NG Offsetting Memory: 1,800 data		
Indentation Direction	Any directions		
Output	RS-232C, SPC		
Power supply	Alkaline AA Battery 2pcs.		
Dimensions	Detector: (Dia. X H) 1.10" x 6.89" (28 x 175mm) Display: (W x D x H) 2.76" x 4.33" x 1.38" (70 x 110 x 35mm)		
Mass	Detector: .26lbs (120g) Display: .44lbs (200g)		
Standard Accessories	Test Block HLD800 (19BAA265) Display (19BAA450) Detector (810-287) Cable (19BAA460) Battery AA (Alkaline) 2pcs.		

Durometers (Digital and Analog)

Durometers are suitable for testing natural rubber, neoprene, polyesters, P.V.C., leather, Thiokol, nitril, wax, vinyl, cellulose acetates, glass, polystyrol and other materials.



811-331
811-333



811-332
811-334



811-335
811-337



811-336
811-338

Order No	Model	Scale	Display	Graduation	Range	Indenter	List Price	Sale Price
811-331	HH-331	Shore A	Analog	1.0	10~90	Blunt Taper	\$518.00	\$467.00
811-332	HH-332	Shore A	Digital	0.5	10~90	Blunt Taper	\$1,110.00	\$999.00
811-333	HH-333	Shore D	Analog	1.0	20~90	Sharp Point	\$518.00	\$467.00
811-334	HH-334	Shore D	Digital	0.5	20~90	Sharp Point	\$1,110.00	\$999.00
811-335	HH-335	Shore A	Analog	1.0	10~90	Blunt Taper	\$518.00	\$467.00
811-336	HH-336	Shore A	Digital	0.5	10~90	Blunt Taper	\$1,110.00	\$999.00
811-337	HH-337	Shore D	Analog	1.0	20~90	Sharp Point	\$518.00	\$467.00
811-338	HH-338	Shore D	Digital	0.5	20~90	Sharp Point	\$1,110.00	\$999.00
64AAA964	Test Block Set (Shore A Scale)						\$168.00	\$152.00
64AAA590	Test Block Set (Shore D Scale)						\$168.00	\$152.00



New Rockwell and Rockwell Superficial Type Hardness Tester

With Real-Time Electronic Test Force Control

FEATURES

- Closed-loop control of testing forces
- Primary and final forces (loads) are applied with unparalleled accuracy and repeatability
- Extended indenter arm reaches inside diameters and hard to reach surfaces at eye level, allowing the operator to easily see where the indenter addresses small or hard to reach parts
- Automatic setting of preliminary test force and application of total test force
- Indenter escape function allows automatic removal of preliminary test force at end of test cycle
- Touch screen operation with a back-lit LCD graphic display
- Hardness scale is set automatically via the touch screen
- Cylindrical and spherical surface compensation
- Auto conversion to all hardness scales or tensile strength

Specifications

Preliminary Test Force	29.42N (3kgf), 98.07N (10kgf)
Test Force	Rockwell 588.4N (60kgf), 980.7N (100kgf), 1471N (150kgf)
	Rockwell Superficial 147.1N (15kgf), 294.2N (30kgf), 441.3N (45kgf)
Force Control	Automatic control (unloading/duration/unloading) with spring deformation feed back
Console/Display Unit	Touch screen operation with back-lit LCD graphic display
Test Force Selection	By touch screen
Load Duration	0 to 120 sec. (1 sec. step)
Maximum Specimen Height	Height: 205mm Depth: 150mm, from center of indenter shaft
Display Indication Functions	Hardness value, Converted hardness value, Test conditions, OK/NG tolerance judgment, statistical processing result. Rockwell/Rockwell superficial hardness testing. Continuous testing. Cylindrical/spherical surface compensation, data offset. Hardness conversion (HV, HK, HRA/B/C/D/F/G/15T/30T/45T/15N/30N/45N, HS, HB, HBW, tensile strength). OK/±NG tolerance judgement, measured data editing, data memory (max 1024 data). SPC calculation (Number of data, max/min/mean values, range, upper/lower limit values, standard deviation, number of passing/defective) Histogram, X-bar & R chart.
Data Output	RS-232C, SPC, Centronics
Dimensions (W x D x H)	9.84" x 26.38" x 23.82" (250 x 670 x 605mm)
Mass	Approx. 132 lbs (60kg)



\$11,700⁰⁰

Our List Price: \$13,000.00
Order Number: 810-202-03A

TM-505D/510D Series 176



Toolmaker's Microscope

The TM-505D/510D is a compact microscope well suited for measuring dimensions and angles of machined metals. It can also be used to check the shape of screws and gears by attaching an optional reticle. Its compact body makes it ideal for use on shop-floors with limited space!

- The eyepiece section of the optical tube incorporates a vernier protractor. Angle measurement is performed easily by turning the protractor to align the cross-hair reticle with the workpiece image.
- Complete selection of interchangeable reticles are available.
- Both the transmitted and reflected illumination intensity can be adjusted to obtain the optimal illumination intensity for the workpiece.
- Two XY stages with different travel ranges, 2" x 2" (50mm x 50mm) and 4" x 2" (100mm x 50mm), are available.
- The TM-505D/510D can output XY coordinate data if Digimatic Mic Heads (optional on 176-811A/812A) are used with it. Highly efficient two-dimensional data processing is available by connecting the Digimatic Mic Heads to an SPC tool such as QC220-MSR.

Order No.	Description	List Price	Sale Price
176-808A	TM-505 With Mic Heads, 2 X 2" Stage	\$4,760.00	\$4,284.00
176-809A	TM-510 With Mic Heads, 4 X 2" Stage	\$6,340.00	\$5,706.00
164-162	Digimatic Micrometer Head	\$797.00	\$638.00
176-152A	Illuminator	\$170.00	\$153.00
937387	40" Mic Head Cable	\$43.95	\$42.00
965013	80" Mic Head Cable	\$51.90	\$49.00



Surftest SJ-201P



\$1,890⁰⁰

Our Regular Price: \$2,100.00
Order Number: **178-923-2A**

FEATURES SJ-201P

- Large characters are displayed on the large easy-to-view LCD.
- Portable for easy measurement anywhere necessary.
- The detector/drive unit can be detached from the display unit for effortless measurement of awkwardly oriented workpieces.
- Wide 350 μ m (-200 μ m to +150 μ m) measurement range.
- Roughness parameters compatible with ISO, DIN, ANSI, and JIS.
- 19 analysis parameters are provided, including the basic Ra, Rq, Rz, and Ry parameters.
- Customize function allows hiding of unnecessary parameters.
- GO/NG judgment on a desired parameter.
- Auto-calibration for simple gain-adjustment.
- Auto-sleep function saves energy.
- Data output is available for SPC operation.
- RS-232C interface enables data transfer to computer or other devices using an external device.
- 2-way power system (AC adapter/rechargeable built-in battery).
- A dedicated carrying case is included for safe transport.
- A precision roughness specimen is supplied.
- A hard copy of the measurement data is available with the optional printer and cable (178-420A.)

Standard detector

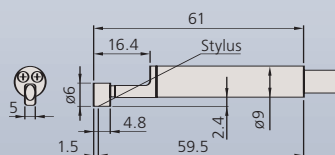

Deep groove detector

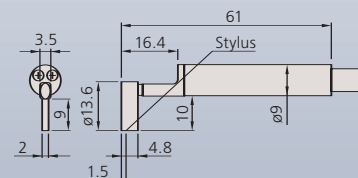

Surftest SJ-301



\$3,591⁰⁰

Our List Price: \$3,990.00
Order Number: **178-954-3A**

Detectors for Surftest SJ-201P and SJ-301

MAC No.	Description	List Price	Sale Price
178-390	Standard Detector	\$405.00	\$365.00
178-391	Detector for Soft Materials	\$405.00	\$365.00
178-392	Small Hole Detector (Min. 4.5mm Dia.)	\$619.00	\$558.00
178-393	Extra Small Hole Detector (Min. 2.8mm Dia.)	\$619.00	\$558.00
178-394	Deep Groove Detector	\$619.00	\$558.00
178-395	Low Force Detector	\$394.00	\$355.00

Surftest SJ-401

FEATURES

- Equipped with 36 kinds of roughness parameters that conform to the latest ISO, DIN, ANSI, and JIS standards.
- A wide-range, high-resolution detector and a straight drive unit provide superior high-accuracy measurement in its class.
- The skidless detector and the curved surface compensation function make it efficient to evaluate cylinder surface roughness.
- Ultra-fine steps, straightness and waviness can be measured by using the skidless measurement function.
- Measured data can be output to an external PC by using an RS-232C cable (optional).
- Includes a roughness specimen.
- Digital filter function for non-distorted roughness profiles.
- GO/NG judgment function.
- Auto-calibration function.

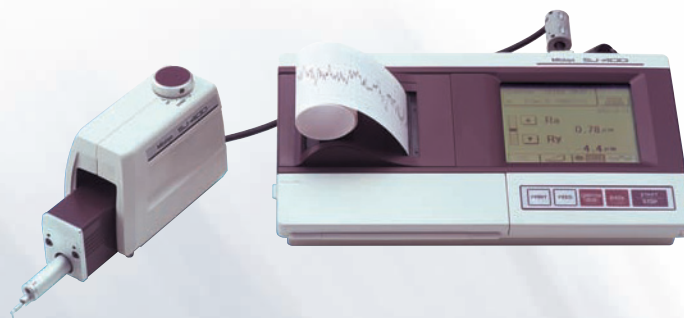

\$6,246⁰⁰

Our List Price: \$6,940.00
Order Number: **178-947-4A**

Detector

Measuring range: 800 μ m
Resolution: 0.000125 μ m (at 8 μ m range)
Drive unit
Straightness/traverse length
SJ-401: 0.3 μ m/25mm

Linear Scales



ABS-Absolute Digital Readout System



NEW!
Now with
5 year
warranty!

AT 715 IP67 Scales

FEATURES

- Bolt Hole Circle Calculation
- Diameter Display and Tool Offsets (Parameter Mode)
- Memory compensation value
- Selecting Coordinates 0 to 10
- Preset
- Zero Approach Machining
- Pitch Approach Machining
- 1/2 Calculation
- inch/mm
- Standard Resolution:
.001"/.0005"/.0002"/.0001"/.00005"
(0.010mm/0.005mm/0.002mm/0.001mm): When connecting AT715
.002"/.0010"/.0005"/.0004"/.0002"/.0001"
(0.020mm/0.010mm/0.004mm/0.002mm): When connecting AT715 Series (DIA.).

Affordable price and High Performance.
KA Counter connected with AT715 scales as an electromagnetic induction system.



Using new Electromagnetic Induction Detection with improved reliability and improved contamination protection.

True Absolute Scale Technology means original part datum point is never lost even when power is off.

The sizes of the AT715 range from 4" (100mm) to 72" (1800mm) with an accuracy at 20°C of 7+13xL0/1000 μm (L0: Effective Length in/mm). It has a response speed of 50m/min and a IP-67 rating for dust and water.

ABS-AOS-DRO Mill Packages (2-Axis)

Order No.	Description/Table Travel	List Price	Sale Price
174-173PM1K	Bridgeport Style 12 x 30"	\$1,310.00	\$1,179.00
174-173PM2K	Bridgeport Style 12 x 36"	\$1,310.00	\$1,179.00
174-173PM5K	Universal Style 16 x 36"	\$1,310.00	\$1,179.00
174-173A	KA-12 (2-Axis)	\$521.00	\$469.00
053906B	Quill Kit Vert. Knee Mill	\$288.00	\$260.00

ABS Digimatic Scale Units with SPC Output

MITUTOYO Digimatic Scale Units can be installed on almost any surface, offering the user precise linear measurement capability with the added benefits of LCD readout and output for recording data and SPC.

FEATURES

- No rack, no pinion, no glass scale. Digimatic Scale is safely embedded in the hardened stainless steel blade.
- All units come with two mounting brackets, each located at either end of the scale.
- Battery life of approximately 1.5 years.

IP-66 Type



Horizontal

Order No.	Range	Resolution	Accuracy	List Price	Sale Price
572-613	4"/100mm	.0005"/0.01mm	.001"/0.03mm	\$252.00	\$227.00
572-614	6"/150mm	.0005"/0.01mm	.001"/0.03mm	\$275.00	\$248.00
572-615	8"/200mm	.0005"/0.01mm	.001"/0.03mm	\$370.00	\$333.00



Order No.	Description	List Price	Sale Price
05CZA624	40" IP Scale Cable	\$81.30	\$78.00
05CZA625	80" IP Scale Cable	\$82.50	\$79.00

Single Function Type



Horizontal

Order No.	Range	Resolution	Accuracy	List Price	Sale Price
572-211-20	6"/150mm	.0005"/0.01mm	.001"/0.03mm	\$221.00	\$199.00
572-212-20	8"/200mm	.0005"/0.01mm	.001"/0.03mm	\$258.00	\$233.00
572-213-10	12"/300mm	.0005"/0.01mm	.002"/0.04mm	\$497.00	\$448.00



Order No.	Description	List Price	Sale Price
959149	40" Scale Cable	\$43.65	\$42.00
959150	80" Scale Cable	\$48.90	\$47.00

Profile Projectors



PH-3515F Horizontal Profile Projector

14" (356mm) Diameter Protractor Screen with crosshair line for easy alignment

FEATURES

- Heavy-Duty, bench-top model with horizontal optical system.
- Erect image on Day-bright screen.
- 14" (356mm) dia. protractor screen with crosshair line for easy alignment.
- Floating-type workstage incorporates linear scales for fast, accurate measurement.
- Suitable for thread pitch measurements — free from blurred or distorted images when the workpiece is angled.

Order No.	Description	List Price	Sale Price
172-848-1A	PH-3515F Main Unit	\$8,930.00	\$8,037.00
264-146A	QM-Data 200	\$2,110.00	\$1,899.00
332-151	Optoeye 200	\$1,430.00	\$1,287.00
12AAE671	Attachment board for Optoeye	\$35.25	\$32.00
174-173A	KA-12 Counter (2-axis)	\$521.00	\$469.00
64AAB003	Counter Tray	\$132.00	\$119.00
050004	PH-3515F Stand	\$1,065.00	\$959.00



PJ-A3000 Vertical Profile Projector

FEATURES

- A series of midsize profile projectors featuring bright, 12.40" (315mm) diameter screens and easy-to-operate XY measurement tables.
- Easy-to-read digital counters are located near the projection screen, thereby minimizing strain associated with excessive movement. A digital angle display eliminates the need to perform complex calculations.
- A floating table makes measuring quicker and easier.
- For edge sensing capabilities, order the Optoeye-200, part number 332-151



Order No.	Description	XY Range	List Price	Sale Price
302-711A	PJ-A3010F-200	8" x 4"	\$11,600.00	\$10,440.00
302-712A	PJ-A3005F-150	5.9" x 2"	\$10,500.00	\$9,450.00
302-713A	PJ-A3010F-100	3.94" x 3.94"	\$9,360.00	\$8,424.00
302-714A	PJ-A3005D-50	2" x 2"	\$7,700.00	\$6,930.00

Optional Accessories

Order No.	Description	List Price	Sale Price
264-146A	QM-Data 200	\$2,110.00	\$1,899.00
332-151	Optoeye 200	\$1,430.00	\$1,287.00
64PMI167	Stand for PJ-A3000	\$632.00	\$569.00
12AAA807	RS-232C Cable	\$46.95	\$43.00
12AAE671	Attachment board (A)	\$35.25	\$32.00

PH-A14 Horizontal Profile Projector

14" (356mm) Screen Diameter Profile Projector with Linear Scales

FEATURES

- Mitutoyo's lens technology and workmanship combine to provide a bright, crisp image for error free inspection.
- 8" x 4" floating-type workstage incorporates linear scales for fast, accurate measurement.
- The workstage provides high accuracy and can handle a workload of up to 100 lbs.
- 10x objective lens and fiber illuminator are standard accessories.

Order No.	Description	List Price	Sale Price
172-810A	PH-A14 unit	\$4,450.00	\$4,005.00
264-146A	QM-Data 200	\$2,110.00	\$1,899.00
332-151	Optoeye 200	\$1,430.00	\$1,287.00
12AAE671	Attachment board for Optoeye	\$35.25	\$32.00
174-173A	KA-12 Counter (2-axis)	\$521.00	\$469.00
58AAA407A	Counter Tray	\$132.00	\$119.00
64AAA129B	PH-A14 Stand	\$650.00	\$585.00





Combination Square Set



UP TO 15% OFF!

FEATURES

- Square, center or protractor heads are attached to the stainless steel blade, allowing versatile measurements on various types of workpieces
- Economy sets not including a protractor head are also available

Square head: Used to set the rule at 90 degrees or 45 degrees to the edge of a workpiece.
 Center head: Used to locate centers of round workpieces
 Protractor head: Used to set the rule at a desired angle to an edge of a workpiece. Also used for measuring angles.

Order No.	Blade Description	Square Head	Center Head	Protractor Head	List Price	Sale Price
180-801	6" (4R) 180-401	180-111**	180-211**		\$83.40	\$71.00
180-802	6" (16R) 180-402	180-111**	180-211**		\$86.50	\$74.00
180-803	12" (4R) 180-501	180-112**	180-212**		\$101.00	\$86.00
180-804	12" (16R) 180-502	180-112**	180-212**		\$104.00	\$89.00
180-805	12" (4R) 180-501	180-112**	180-212**	180-301**	\$175.00	\$149.00
180-806	12" (16R) 180-502	180-112**	180-212**	180-301**	\$179.00	\$153.00
180-901	6" (4R) 180-401	180-101*	180-201*		\$106.00	\$91.00
180-903	12" (4R) 180-501	180-102*	180-202*		\$131.00	\$112.00
180-904	12" (16R) 180-502	180-102*	180-202*		\$135.00	\$115.00
180-905	12" (4R) 180-501	180-102*	180-202*	180-301**	\$206.00	\$176.00
180-906	12" (16R) 180-502	180-102*	180-202*	180-301**	\$209.00	\$178.00
Inch / Metric						
180-807	12" / 300mm (180-503)	180-112**	180-212**	180-301**	\$175.00	\$149.00
180-907	12" / 300mm (180-503)	180-102*	180-202*	180-301**	\$209.00	\$178.00
Metric						
180-810	300mm (180-505)	180-112**	180-212**	180-301**	\$175.00	\$149.00
180-910	300mm (180-505)	180-102*	180-202*	180-301**	\$209.00	\$178.00

*Hardened cast iron heads **non hardened head

Inch/Metric Blades Only

Order No.	Blade Description	Graduations	Accuracy (mm)	List Price	Sale Price
180-401	6" (4R)	1/8", 1/16", 1/32", 1/64"	+ .004" (+0.1mm) - .0035" (-0.09mm)	\$32.05	\$28.00
180-402	6" (16R)	1/32", 1/64", 1/50", 1/100"	+ .004" (+0.1mm) - .0035" (-0.09mm)	\$36.30	\$31.00
180-403	6" x 150mm	1/32", 1/64", 0.5mm, 1mm	+ .004" (+0.1mm) - .0035" (-0.09mm)	\$36.30	\$31.00
180-405	150mm	0.5mm, 1mm, 0.5mm, 1mm	+ .004" (+0.1mm) - .0035" (-0.09mm)	\$36.30	\$31.00
180-501	12" (4R)	1/8", 1/16", 1/32", 1/64"	+ .005" (+0.13mm) - .0035" (-0.09mm)	\$38.45	\$33.00
180-502	12" (16R)	1/32", 1/64", 1/50", 1/100"	+ .005" (+0.13mm) - .0035" (-0.09mm)	\$41.65	\$36.00
180-503	12" x 300mm	1/32", 1/64", 0.5mm, 1mm	+ .005" (+0.13mm) - .0035" (-0.09mm)	\$41.65	\$36.00
180-505	300mm	0.5mm, 1mm, 0.5mm, 1mm	+ .005" (+0.13mm) - .0035" (-0.09mm)	\$41.65	\$36.00
180-701	18" (4R)	1/8", 1/16", 1/32", 1/64"	+ .006" (+0.15mm) - .0035" (-0.09mm)	\$69.85	\$60.00
180-702	18" (16R)	1/32", 1/64", 1/50", 1/100"	+ .006" (+0.15mm) - .0035" (-0.09mm)	\$72.55	\$62.00
180-703	18" x 450mm	1/32", 1/64", 0.5mm, 1mm	+ .006" (+0.15mm) - .0035" (-0.09mm)	\$72.55	\$62.00
180-705	450mm	0.5mm, 1mm, 0.5mm, 1mm	+ .006" (+0.15mm) - .0035" (-0.09mm)	\$72.55	\$62.00
180-601	24" (4R)	1/8", 1/16", 1/32", 1/64"	+ .007" (+0.18mm) - .0035" (-0.09mm)	\$80.50	\$69.00
180-602	24" (16R)	1/32", 1/64", 1/50", 1/100"	+ .007" (+0.18mm) - .0035" (-0.09mm)	\$84.30	\$72.00
180-603	24" x 600mm	1/32", 1/64", 0.5mm, 1mm	+ .007" (+0.18mm) - .0035" (-0.09mm)	\$84.30	\$72.00

Small Tools



Digital Protractor

The **Digital Protractor** present inclination values on an easy to read LCD. The measurements are generated by an electronic gravity sensor and processed by the latest low power electronic circuit technology.

FEATURES

- Machined aluminum frame
- Alternate reference (zero)
- Reading hold
- Simple calibration requiring no special fixtures
- Display remains upright to view at all angles



Order No.	Description	Range	Resolution	Accuracy	List Price	Sale Price
950-315	Pro 360 Digital Protractor	360° (90° x 4)	0.1°	±0.1° Level ±10° ±0.2° Max. error	\$241.00	\$205.00
950-316	Pro 3600 Digital Protractor With RS-232 Output	360° (90° x 4)	0.01° (0° to 9.99°) 0.1° (10° to 90°)	±0.05° (0° to 10°) ±0.2° (10° to 80°) ±0.1° (80° to 90°)	\$397.00	\$338.00
50AAA983A	RS-232 Cable with foot switch				\$169.00	\$144.00
64PPP794	Magnetic Base for 950-315, 950-316				\$57.70	\$50.00

Digital Hand Tachometers

Order No.	Rotation Speed
982-551	1-25,000 RPM
982-552	Contact: 6-25,000 RPM Non-Contact: 6-99,000 RPM



982-551
Contact Style



982-552

Order No.	Description	List Price	Sale Price
982-551	Contact Style Digital Tachometer	\$252.00	\$215.00
982-552	Contact/Non-Contact Style Digital Tachometer	\$314.00	\$267.00

Contact /Non-Contact Style

Zero-Setter

Fast and sure establishment of zero reference point with built-in indicator. Spring loaded setting face to safe guard against damage from over run. Body dia. 1.44" (36.5mm)
Wooden case included

Order No.	Height	Graduation	List Price	Sale Price
950-111	1"	.0005"	\$331.00	\$282.00
950-112	25mm	0.01mm	\$331.00	\$282.00



950-111

950-112

Small Hole Gage Set

FEATURES

- Used with an outside micrometer for measuring inside diameter of bores.
- 4 sizes of gages are supplied in a fitted pouch.
- Extra long for gaging deep and shallow holes, slots, and similar workpieces.
- Gaging surface is fully hardened to insure long tool life.

Order No.	Description	List Price	Sale Price
154-901	4 Piece Small Hole Gage Set .125 - .500" Dia.	\$97.05	\$83.00



Small Tools



Telescoping Gage Set



FEATURES

- Spring-loaded plunger expands within the bore (or groove), allowing determination of the internal diameter (or groove width).
- With a knurled clamp.
- Supplied in a fitted pouch.

Inch	Set Order No.	Range	Included in Set	List Price	Sale Price
	155-903	.313" - 6"	.313" - .5" (155-121)	\$178.00	\$152.00
			.5" - .75" (155-122)		
			.75" - 1.25" (155-123)		
			1.25" - 2.125" (155-124)		
			2.125" - 3.5" (155-125)		
	155-904	.5" - 6"	3.5" - 6" (155-126)	\$156.00	\$133.00
			155-122, 155-123, 155-124 155-125, 155-126		

Spring Dividers and Calipers

UP TO 15% OFF!

Order No.	Description	List Price	Sale Price
Spring Dividers			
950-212	6" Spring Divider	\$16.00	\$14.00
950-213	8" Spring Divider	\$20.00	\$17.00
Outside Spring Calipers			
950-222	6" Outside Spring Caliper	\$16.00	\$14.00
950-223	8" Outside Spring Caliper	\$20.00	\$17.00
Inside Spring Calipers			
950-232	6" Inside Spring Caliper	\$16.00	\$14.00
950-233	8" Inside Spring Caliper	\$20.00	\$17.00



Spring Divider



Outside Spring Caliper



Inside Spring Caliper

Adjustment screw is centrally located for easy adjustment over the entire range. Sturdy, steel construction with solid nuts.

Universal Bevel Protractor

FEATURES

- High-precision angle gage for accurate angle measurement of machines, molds, and jigs.
- Can be attached to height gages.

UP TO 15% OFF!

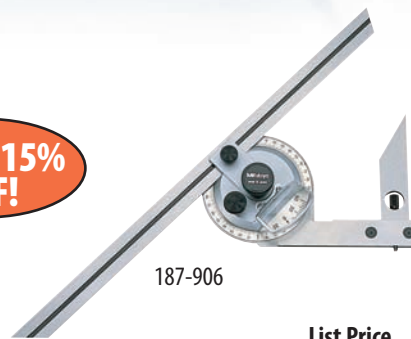

187-906

Order No.	Graduations		Remarks	List Price	Sale Price
	Dial	Vernier			
187-904	1°	5 Minutes	With 6" blade and clamp box for inch height gage	\$296.00	\$252.00
187-906	1°	5 Minutes	With 12" blade and clamp box for inch height gage	\$309.00	\$263.00

Engineers Steel Squares

Used in visual checks of parts for squareness and to position one item perpendicular to another. True 90° angles inside and outside. Beams and blades are lapped for straightness and parallelism. Blade length is measured from inner edge of beam to end of blade.

Order No.	Description	List Price	Sale Price
916-598	4 Piece Engineers Square Set 2", 3", 4", 6"	\$77.70	\$67.00
916-599	4 Piece Engineers Square Set 4", 6", 9", 12"	\$155.00	\$132.00

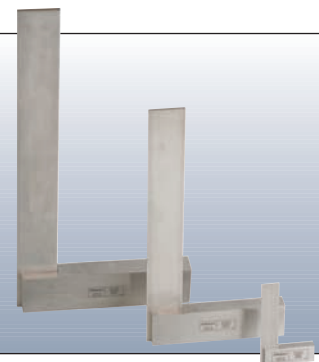

U-Wave Wireless System

The U-WAVE system enables easy wireless data communication from a measuring tool to a PC using the Digimatic protocol. Measurement efficiency is improved by eliminating long and cumbersome data cables. The user-friendly interface allows data to be loaded into any software product that accepts keyboard input, such as Excel or Notepad.

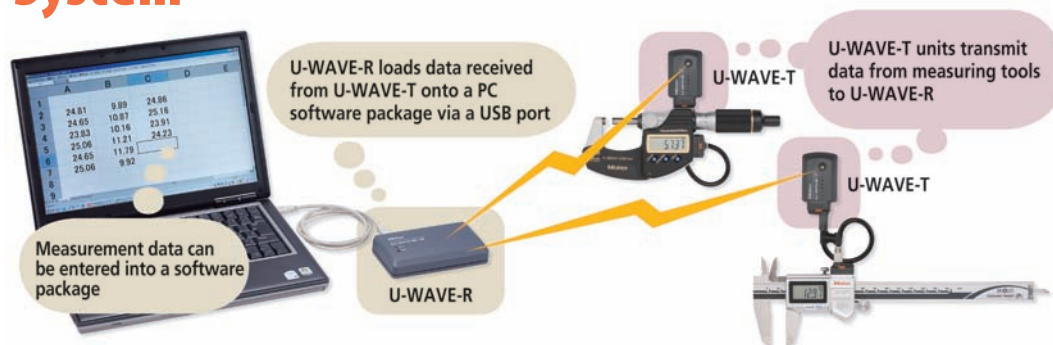

How to "Spec" a U-Wave System:

1. One U-Wave-R required per system (will support up to 100 U-Wave-T): Order No. **02AZD810D**
2. One U-Wave-T required per tool: Order No. **02AZD730D**
3. Select the required connecting cable (cable length approx. 6").
Use the convenient U-Wave Cable Selection Chart to convert your existing cable part number to the corresponding U-Wave cable order number.

New!

U-Wave-R

FEATURES

- Supports up to 100 U-Wave-T
- Comes complete with U-WavePak set-up/data input software.
- U-WavePak, standard with U-Wave-R features a keyboard interface function. This allows measurement data to be easily entered into in Excel, Notepad or other formats that accepts numeric value input via a keyboard.
- Supplied with USB connecting cable.
- MeasurLink® V6.1 Real-Time PLUS supports the U-Wave System.



U-Wave-T

FEATURES

- Is IP67 rated
- IP67 cables available for your Mitutoyo waterproof tools.
- Battery life approx. 400,000 data transmissions.
- Up to 60 feet transmission range. Actual range depends on the local radio transmission characteristics.



UP TO 10% OFF!



Order No.	Description	Use For Cables	List Price	Sale Price
02AZD810D	U-Wave-R 02AZD810D		\$433.00	\$390.00
02AZD730D	U-Wave-T 02AZD730D		\$191.00	\$172.00
02AZD790A	U-Wave Connecting Cable A	05CZA624 or 05CZA625	\$94.80	\$86.00
02AZD790B	U-Wave Connecting Cable B	05CZA662 or 05CZA663	\$94.80	\$86.00
02AZD790C	U-Wave Connecting Cable C	959149 or 959150	\$94.80	\$86.00
02AZD790D	U-Wave Connecting Cable D	936937 or 965014	\$94.80	\$86.00
02AZD790E	U-Wave Connecting Cable E	937387 or 965013	\$94.80	\$86.00
02AZD790F	U-Wave Connecting Cable F	905338 or 905409	\$94.80	\$86.00
02AZD790G	U-Wave Connecting Cable G	21EAA194 or 21EAA190	\$94.80	\$86.00

- Coordinate Measuring Machines
- Vision Measuring Systems
- Surface, Form and Contour Measurement
- Optical Measuring
- Sensor Systems
- Hardness Measuring
- Digital Scale and DRO Systems
- Small Tool Instruments and Data Management

Distributed By:

Note: All information regarding our products, and in particular the illustrations, drawings, dimensional and performance data contained in this printed matter as well as other technical data are to be regarded as approximate average values. We therefore reserve the right to make changes to the corresponding designs. The stated standards, similar technical regulations, descriptions and illustrations of the products were valid at the time of printing. In addition, the latest applicable version of our General Trading Conditions will apply. Only quotations submitted by ourselves may be regarded as definitive. Mitutoyo products are subject to US Export Administration Regulations (EAR). Re-export or relocation of Mitutoyo products may require prior approval by an appropriate governing authority.

Trademarks and Registrations

Designations used by companies to distinguish their products are often claimed as trademarks. In all instances where Mitutoyo America Corporation is aware of a claim, the product names appear in initial capital or all capital letters. The appropriate companies should be contacted for more complete trademark and registration information.

Mitutoyo America Corporation
www.mitutoyo.com

One Number to Serve You Better
1-888-MITUTOYO (1-888-648-8869)

M³ Solution Centers

- Aurora, Illinois
(Corporate Headquarters)
- Westford, Massachusetts
- Huntersville, North Carolina
- Mason, Ohio
- Plymouth, Michigan
- City of Industry, California

Mitutoyo
Precision is our Profession